

Triple Band

50/144/430

YAESU

50/144/430MHz TRIPLE-BAND HEAVY DUTY FM TRANSCEIVER

VX-5R

OPERATING MANUAL

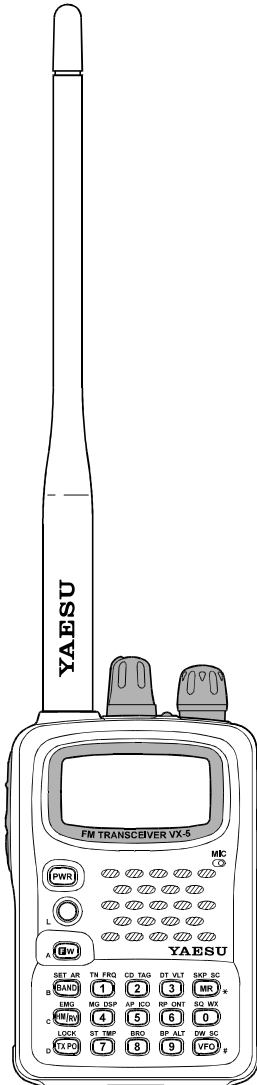

VERTEX STANDARD CO., LTD.

4-8-8 Nakameguro, Meguro-Ku, Tokyo 153-8644, Japan

VERTEX STANDARD

US Headquarters

10900 Walker Street, Cypress, CA 90630, U.S.A.

YAESU EUROPE B.V.

P.O. Box 75525, 1118 ZN Schiphol, The Netherlands

YAESU UK LTD.

Unit 12, Sun Valley Business Park, Winnall Close
Winchester, Hampshire, SO23 0LB, U.K.

VERTEX STANDARD HK LTD.

Unit 5, 20/F., Seaview Centre, 139-141 Hoi Bun Road,
Kwun Tong, Kowloon, Hong Kong

Contents

Introduction	1	Disabling the BUSY/TX LED	33
Controls & Connections	2	Battery Utilization Monitor	33
Display Icons & Indicators	3	Automatic Power-Off (APO) Feature	33
Keypad Function	4	Automatic Power-On Feature	34
Accessories & Options	6	Keyboard Locking	34
Installation of Accessories	7	Disabling the Keypad Beeper	35
Antenna Installation	7	Checking the Battery Voltage	35
Belt Clip Installation	7	Temperature Display	35
Installation of FNB-80LI Battery Pack	8	DTMF Operation	36
Installation of FBA-23 Alkaline Battery Case	9	Emergency Channel Operation	37
Battery Life Information	10	ARTS (Automatic Range Transponder System)	38
AC Operation Using NC-72	10	Memory Mode	42
Interface of Packet TNCs	11	Memory Storage	42
Operation	12	Storing Independent Transmit Frequencies	42
Switching Power On and Off	12	Memory Recall	43
Adjusting the Volume Level	12	HOME Channel Memory	43
Squelch Adjustment	12	Labeling Memories	44
Selecting the Operating Band	13	Memory Offset Tuning	44
Frequency Navigation	14	Masking Memories	45
Transmission	15	Memory Group Operation	45
AM Broadcast Reception	15	Scanning	46
AM Aircraft Reception	16	VFO Scanning	47
FM Broadcast/TV Audio Reception	16	Memory Scanning	47
Weather Broadcast Reception	17	How to Skip a Channel During Memory Scan ..	48
Keypad/LCD Illumination	18	Preferential Memory Scan	48
Advanced Operation	20	Programmable Memory Scan (PMS)	49
Setting the Frequency Display Image Size	20	“Priority Channel” Scanning (Dual Watch)	50
VFO Split Mode	21	Automatic Lamp Illumination on Scan Stop	51
VFO Linking	22	Band Edge Beeper	51
Changing the Channel Steps	22	Smart Search Operation	52
Changing the Operating Mode	23	Spectrum Analyzer Operation	53
Repeater Operation	24	Barometric Pressure/ Altitude Metering	54
CTCSS Operation	26	Display Customization	56
DCS Operation	27	Icon Mode	56
Tone Search Scanning	28	Meter Symbols	56
CTCSS/DCS Bell Operation	29	Power-Off Display Mode	57
Tone Calling (1750 Hz)	29	Display Contrast	57
Changing the Transmitter Power Level	30	Reset	58
Changing the TX Deviation Level	30	Cloning	59
Transmitter Time-Out Timer (TOT)	31	Set Mode	60
Busy Channel Lock-Out (BCLO)	31	Specifications	70
Receive Battery Saver Setup	32	Installation of the SU-1	72
TX Battery Saver	32		

Introduction

The **VX-5R** is a miniature triband FM transceiver with extensive receive frequency coverage, providing leading-edge features for VHF and UHF two-way amateur communications along with unmatched monitoring capability.

The **VX-5R**'s small size allows you to take it anywhere - hiking, skiing, or while walking around town, and its operating flexibility brings the user many avenues of operating enjoyment. Besides 50, 144, and 430 MHz transceive operation, the **VX-5R** provides receive coverage of the AM (MF) and FM broadcast bands, HF Shortwave Bands up to 16 MHz, VHF and UHF TV bands, the VHF AM aircraft band, and a wide range of commercial and public safety frequencies! And the optional Barometer pressure Sensor Unit provides readout of barometric pressure and altitude while mountain climbing or hiking.

The transmitter section provides 5 Watts of clean power output on the 50 MHz and 144 MHz bands with the supplied **FNB-80LI** Battery Pack, and 4.5 Watts output on 430 MHz. When 13.8V DC power is supplied from an external source, power output is five watts on all bands. A wide variety of tone signaling formats are built into the **VX-5R**, in addition to Yaesu's exclusive ARTS™ (Auto-Range Transponder System), which "beeps" the user when you move out of communications range with another ARTS™-equipped station.

We appreciate your purchase of the **VX-5R**, and encourage you to read this manual thoroughly, so as to learn about the many exciting features of your exciting new Yaesu hand-held transceiver!

Controls & Connections

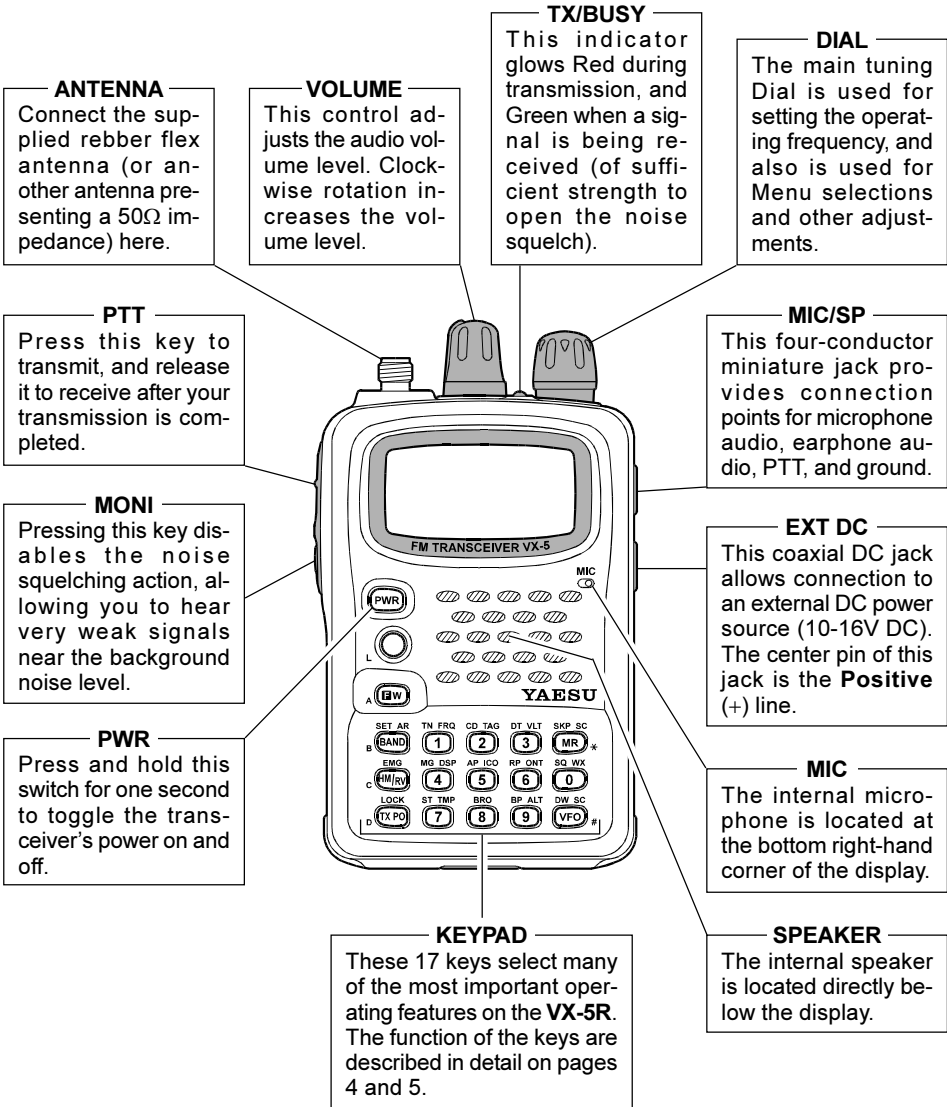

Display Icons & Indicators

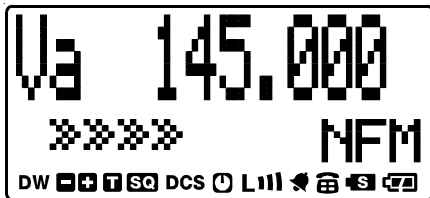

Double size display (default)



Press and hold the ^{MG DSP} (4) key for one second

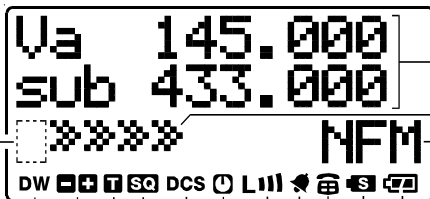

Small Character display

Frequency/Data Field

S- and TX Power Meter
Operating Mode

- Low Battery!
- Battery Saver Active (page 32)
- DTMF Autodialer Active (page 36)
- Bell Alarm Active (page 29)
- Low TX Power Selected (page 30)
- Automatic Power-Off Active (page 33)
- Digital Coded Squelch Active (page 27)
- CTCSS Decoder Active (page 26)
- CTCSS Encoder Active (page 26)
- Repeater Shift Direction (page 24)
- Dual Watch Active (page 50)

- F** — Alternate Key Functions Active
- L** — LOCK Feature Active (page 34)
- S** — Set Mode Active (page 60)
- W** — Memory Write Feature Active (page 42)

ICON

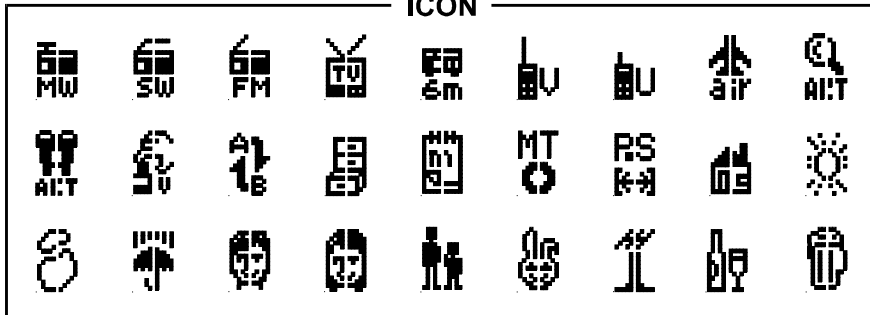

Keypad Functions

	[BAND(SET)AR]	[1(TN)FRQ]	[2(CD)TAG]
Press Key	Change the Frequency Band	Frequency Entry Digit "1"	Frequency Entry Digit "2"
Press [F/W] +	Enter the "Set" (Menu) mode.	Activate CTCSS or DCS Operation.	Select the CTCSS tone frequency or DCS code number.
Press and hold Key	Activate the ARTS™ Feature.	Enables display of the Sub-band Frequency.	Select the display type (Frequency or Frequency+Alpha-numeric Tag) during Memory operation.
	[HM/RV(EMG)]	[4(MG)DSP]	[5(AP)ICO]
Press Key	Reverse the transmit and receive frequencies while working through a repeater.	Frequency Entry Digit "4"	Frequency Entry Digit "5"
Press [F/W] +	Switch to the "Home" (favorite frequency) Channel.	Activate the Memory Group mode.	Activate the Automatic Power-Off Feature.
Press and hold Key	Activate the EMERGENCY Feature.	Switches display between <i>Large Character</i> and <i>Small Character mode</i> .	Switch the display levels between the "Alpha-numeric" and "Icon" formats.
	[TX PO(LOCK)]	[7(ST)TMP]	[8(BRO)]
Press Key	Select the desired transmitter power output level.	Frequency Entry Digit "7"	Frequency Entry Digit "8"
Press [F/W] +	Activate the Key Lockout Feature.	Select the synthesizer steps to be used during VFO operation.	None
Press and hold Key	None	Display the current temperature inside the transceiver's case.	Display the current Barometric Pressure.

Keypad Functions

[3(DT)VLT]	[MR(SKP)SC]		[PTT]
Frequency Entry Digit "3"	Switch to the Memory mode.	Press Key	Transmit.
Activate the DTMF Autodialer Function.	Designate a Memory Channel to be "skipped" during scanning.	Press [F/W] +	Temporary High Power Transmit.
Display the Battery Type and Battery Voltage.	Initiate Memory Channel scanning.	Press and hold Key	Transmit.
[6(RP)ONT]	[0(SQ)WX]		[MON]
Frequency Entry Digit "6"	Frequency Entry Digit "0"	Press Key	USA version: Disable the Noise and Tone Squelch. European version: Activate the T. CALL.
Select the direction of the uplink frequency shift (either "-", "+" or simplex) during repeater operation.	Adjust the Squelch threshold level.	Press [F/W] +	Reverse the transmit and receive frequencies while working through a repeater.
Display the operating time and total transmit time since you most recently turned the transceiver on.	Recall the "Weather" broadcast channel.	Press and hold Key	None
[9(BP)ALT]	[VFO(DW)SC]		[LAMP]
Frequency Entry Digit "9"	Select the VFO mode.	Press Key	Illuminate the LCD and keypad for 5 seconds.
Turn the keypad's Beeper on or off.	Activate the Dual Watch feature.	Press [F/W] +	Activate the Spectrum Analyzer (Spectra-Scope™) feature.
Display the current Altitude.	Activate VFO scanning.	Press and hold Key	Illuminate the LCD and keypad until you press the key again.

Accessories & Options

ACCESSORIES SUPPLIED WITH THE VX-5R

FNB-80LI Battery Pack (7.2V/1300mAh)

NC-72B/C/F/U Battery Chareger

Belt Clip

Hand Strap

Antenna

Operating Manual

Warranty Card

AVAILABLE OPTIONS FOR YOUR VX-5R

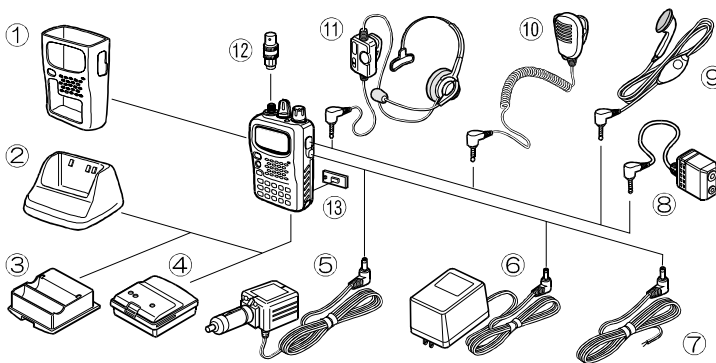

- ① **CSC-73** Soft Case
- ② **CD-15** Rapid Charger (requires **NC-72B/C/F/U**)
- ③ **FBA-23** 2 x “AA” Cell Battery Case (batteries not supplied)
- ④ **FNB-80LI** Battery Pack
- ⑤ **E-DC-5B** DC Cable w/Noise Filter
- ⑥ **NC-72B/C/F/U** Battery Chareger
- ⑦ **E-DC-6** DC Cable; plug and wire only
- ⑧ **CT-44** Microphone Adapter
- ⑨ **MH-37A4B** Earpiece/Microphone
- ⑩ **MH-34B4B** Speaker/Microphone
- ⑪ **VC-25** VOX Headset
- ⑫ **CN-3** BNC-to-SMA Adapter
- ⑬ **SU-1** Barometric Pressure Sensor Unit
- ⑭ **CT-27** Cloning Cable

Availability of accessories may vary. Some accessories are supplied as standard per local requirements, while others may be unavailable in some regions. Consult your Yaesu Dealer for details regarding these and any newly-available options. Connection of any non-Yaesu-approved accessory, should it cause damage, may void the Limited Warranty on this apparatus.

Installation of Accessories

ANTENNA INSTALLATION

The supplied antenna provides good results over the entire frequency range of the transceiver. However, for enhanced base station medium-wave and shortwave reception, you may wish to connect an external (outside) antenna.

The supplied antenna includes a “Base” and an “Extender Element.” The Extender Element should be used below 54 MHz, and its installation will still allow satisfactory 144/430 MHz operation.

To install the supplied antenna

Hold the bottom end of the antenna, then screw it onto the mating connector on the transceiver until it is snug. Do not overtighten by use of extreme force.

When operating the **VX-5R** on frequencies lower than the 50 MHz band, disconnect the antenna cap from the base antenna then screw the Extender Element onto the Base Antenna.

Notes:

- Never transmit without having an antenna connected.
- When installing the supplied antenna, never hold the upper part of the antenna while screwing it onto the mating connector on the transceiver.
- If using an external antenna for transmission, ensure that the SWR presented to the transceiver is 1.5:1 or lower.
- Take care not lose the antenna cap when removing it from the Base Antenna.

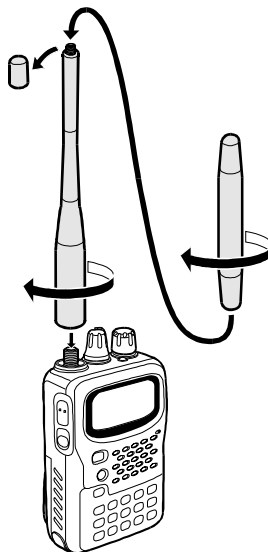

BELT CLIP INSTALLATION

To install the Belt Clip, first place the loop of the Hand Strap into the groove at the top of the Belt Clip, and run the loop of the strap around the round mounting ridge for the Belt Clip. Now insert the mounting screw through the belt clip, and affix it snugly to the mounting hole on the back of the transceiver, being careful not to allow the Hand Strap to become mis-aligned.

Do not install the supplied Belt Clip Mounting Screws if you are not installing the Belt Clip! Also, do not use an improper screw for mounting the Belt Clip! An improper screw may cause a “short circuit” to the internal circuitry, causing serious damage!

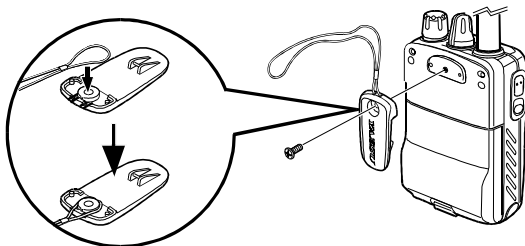

Installation of Accessories

INSTALLATION OF FNB-80LI BATTERY PACK

The **FNB-80LI** is a high-performance Lithium-Ion battery providing high capacity in a very compact package. Under normal use, the **FNB-80LI** may be used for approximately 300 charge cycles, after which operating time may be expected to decrease. If you have an old battery pack which is displaying capacity which has become diminished, you should replace the pack with a new one.

- Push the bottom latch slightly to the “**OPEN**” position.
- Install the **FNB-80LI** as shown in the illustration.
- Re-lock the bottom plate by carefully pressing the hinged latch cover back into its normal operating position.

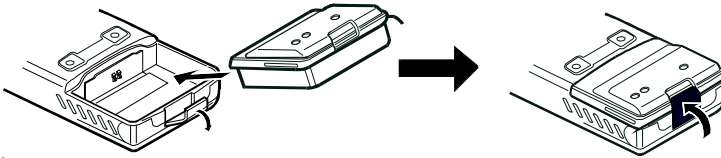

If the battery has never been used, or its charge is depleted, it may be charged by connecting the **NC-72B/C/F/U** Battery Charger, as shown in the illustration, to the **EXT DC** jack. If only 12 ~ 16 Volt DC power is available, the optional **E-DC-5B** or **E-DC-6** DC Adapter (with its cigarette lighter plug) may also be used for charging the battery, as shown in the illustration.

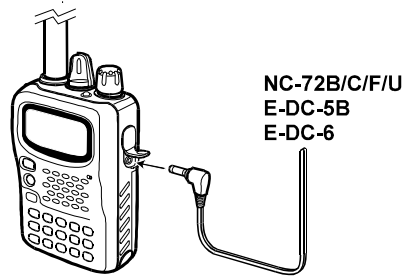

The display will indicate “now charging” while the battery is being charged. When charging is finished, the display will change to indicate “complete.”

Installation of Accessories

INSTALLATION OF FBA-23 (OPTION) ALKALINE BATTERY CASE

The optional **FBA-23** Battery Case allows receive monitoring using two “AA” size Alkaline batteries. Alkaline batteries can also be used for transmission in an emergency, but power output will only be 300 mW, and battery life will be shortened dramatically.

To Install Alkaline Batteries into the FBA-23

- Slide the batteries into the **FBA-23** as shown in the illustration, with the Negative [-] side of the batteries touching the *spring* connections inside the **FBA-23**.
- Unlock the bottom plate by pushing the latch in the “**OPEN**” direction.
- Install the **FBA-23** as shown in the illustration, with the [+] side facing the bottom of the transceiver.
- Re-lock the bottom plate by carefully pressing the latch cover back into its normal operating position.

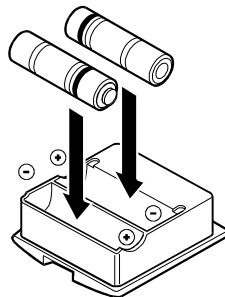

The **FBA-23** does not provide connections for charging, since Alkaline cells cannot be re-charged. Therefore, the **NC-72B/C/F/U**, **E-DC-5B**, or **E-DC-6** may safely be connected to the **EXT DC** jack when the **FBA-23** is installed.



Notes:

- The **FBA-23** is designed for use only with AA-type Alkaline cells.
- If you do not use the **VX-5R** for a long time, remove the Alkaline batteries from the **FBA-23**, as battery leakage could cause damage to the **FBA-23** and/or the transceiver.

Installation of Accessories

BATTERY LIFE INFORMATION

When the battery charge is almost depleted, a “Low Voltage” indicator will appear on the display. When this icon appears, it is recommended that you charge the battery soon.

Operating Band	Battery Life (Approx.)		Low Voltage Indicator
	FNB-80LI	FBA-23	
50 MHz ⁽¹⁾	6.5 hours	7.5 hours	 : Battery is nearing depletion. Prepare to replace the battery. Prepare to charge the battery.  : Battery voltage is <i>critically low</i> . Prepare to replace the battery. Prepare to charge the battery.
144 MHz ⁽¹⁾	6 hours	7 hours	
430 MHz ⁽¹⁾	5.5 hours	6 hours	
Other Bands ⁽²⁾	15 hours	9 hours	

(1) TX 6 sec., RX 6 sec. and Squelched 48 sec.

(2) Continuous signal reception

The current battery voltage can be displayed manually on the LCD, by following the instructions on page 35.

Battery capacity may be reduced during extremely cold weather operation. Keeping the radio inside your parka may help preserve the full charge capacity.

AC OPERATION USING NC-72B/C/F/U (RECEIVING ONLY)



The **VX-5R** may be operated from your house current by use of the supplied **NC-72B/C/F/U** Battery Charger.

To use the **NC-72B/C/F/U**, turn the transceiver off, then plug the miniature connector of the Battery Charger into the **EXT DC** jack on the side of the radio. Now plug the Battery Charger into the wall outlet. You may now turn on the transceiver.

Important Notice

When using an external DC power source supplied via the **E-DC-5B** or **E-DC-6**, if power is momentarily interrupted a safety feature will be activated inside the **VX-5R**, so as to minimize the possibility of damage to the microprocessor. Such a power interruption might occur when a vehicle's ignition is turned on or off, or if the DC power cable is unplugged, or if the DC power supply is turned off.

In the event of such a momentary power interruption, the **VX-5R** will return to the original VFO or Memory Channel *to which the VX-5R was tuned when it was first turned on during this operating session*. For example, if you started operation on Memory Channel 2, at 145.400 MHz, but DC power input is interrupted later while you are on Memory Channel 25, The **VX-5R** will revert to Memory Channel 2 (145.400 MHz) when the power situation stabilizes.

This is a (normal) protection feature, and you may quickly return to Memory Channel 25 by pressing  →  → .

Interface of Packet TNCs

The **VX-5R** may be used for Packet operation, using the optional **CT-44** microphone adapter (available from your Yaesu dealer) for easy interconnection to commonly-available connectors wired to your TNC. You may also build your own cable using a four-conductor miniature phone plug, per the diagram below.

The audio level from the receiver to the TNC may be adjusted by using the **VOLUME** knob, as with voice operation. The input level to the **VX-5R** from the TNC should be adjusted at the TNC side; the optimum input voltage is approximately 5 mV at 2 k Ω .

Be sure to turn the transceiver and TNC off before connecting the cables, so as to prevent voltage spikes from possibly damaging your transceiver.

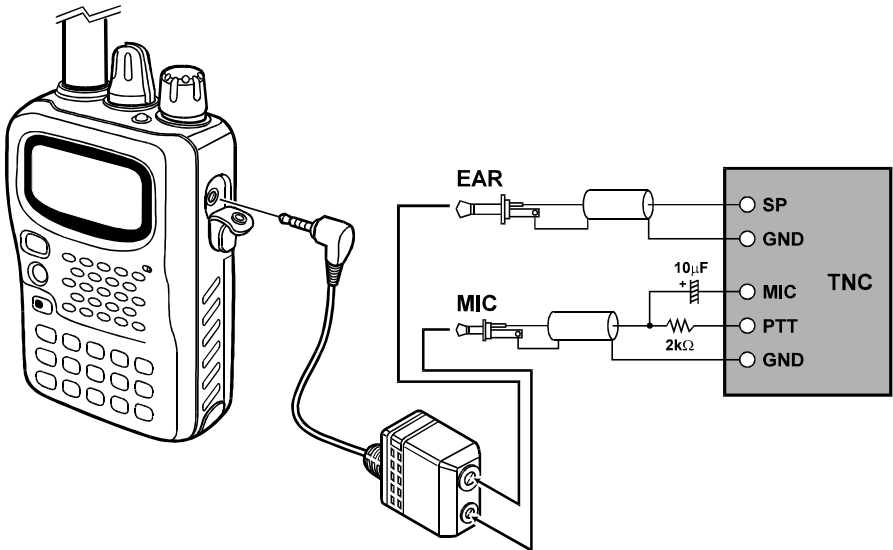

Operation



*Hi! I'm R. F. Radio, and I'll be helping you along as you learn the many features of the **VX-5R**. I know you're anxious to get on the air, but I encourage you to read the "Operation" section of this manual as thoroughly as possible, so you'll get the most out of this fantastic new transceiver. Now...let's get operating!*

SWITCHING POWER ON AND OFF

- ① Be sure the battery pack is installed, and that the battery is fully charged. Connect the antenna to the top panel **ANTENNA** jack.
- ② Press and hold in the orange **PWR** switch (on the left side of the front panel) for one second. Two beeps will be heard when the switch has been held long enough, and the frequency display will soon appear. After another two seconds, the receive-mode Battery Saver function will become active, unless you have disabled it (see page 32).
- ③ To turn the **VX-5R** off, press and hold in the **PWR** switch again for one second.



If you don't hear the two "Beep" tones when the radio comes on, the Beeper may have been disabled via the Menu system. See page 35, which tells you how to reactivate the Beeper.

ADJUSTING THE VOLUME LEVEL

Rotate the **VOLUME** control (immediately to the right of the Antenna) to set the desired audio level. Clockwise rotation increases the volume level.

SQUELCH ADJUSTMENT

The **VX-5R**'s Squelch system allows you to mute the background noise when no signal is being received. Not only does the Squelch system make "standby" operation more pleasant, it also significantly reduces battery current consumption.

The Squelch system may be adjusted independently for the FM and Wide-FM (FM Broadcast) modes.

- ① Press the **[F/W]** key momentarily, then immediately press **[0(SQ)WX]**. This provides a "short-cut" to Menu Item #01 (SQUELCH).
- ② Now rotate the **DIAL** knob clockwise; you will notice that the noise will disappear after a few "clicks" of the **DIAL**. When you find the point where the background noise is just silenced, (typically at a setting of about "3" or "4" on the scale), leave the **DIAL** at that setting; this is point of maximum sensitivity to weak signals.
- ③ When you are satisfied with the Squelch threshold setting, press the **PTT** key momentarily to save the new setting and exit to normal operation.
- ④ You may also adjust the Squelch setting by using the "Set" (Menu) mode. See page 61 for details.



If you're operating in an area of high RF pollution, you may need to consider "Tone Squelch" operation using the built-in CTCSS Decoder. This feature will keep your radio quiet until a call is received from a station sending a carrier which contains a matching (subaudible) CTCSS tone. Or if your friends have radios equipped with DCS (Digital Coded Squelch) like your VX-5R has, try using that mode for silent monitoring of busy channels.

SELECTING THE OPERATING BAND

The **VX-5R** covers an incredibly wide frequency range, over which a number of different operating modes are used. Therefore, the **VX-5R**'s frequency coverage has been divided into different operating bands, each of which has its own pre-set channel steps and operating modes. You can change the channel steps and operating modes later, if you like (see pages 22 and 23).

To Change Operating Bands

- ① Press the **[BAND(SET)AR]** key repetitively. You will see the LCD indication change as you press the **[BAND(SET)AR]** key.
- ② The **VX-5R** uses a dual VFO system (explained in detail on page 20). To switch from the "Main" VFO (VFO-A) to the "Sub" (VFO-B) VFO instantly, press the **[VFO(DW)SC]** key momentarily. Pressing the **[VFO(DW)SC]** key once more will return the **VX-5R** to VFO-A.
- ③ Once you have selected the desired band, you may initiate manual tuning (or scanning) per the discussions below.

BAND	Frequency Range
BC Band	0.5 ~ 1.8 MHz
SW Band	1.8 ~ 16 MHz
FM BC	59 ~ 108 MHz
TV Band	174 ~ 222 & 470 ~ 729 MHz
50 MHz Ham	48 ~ 59 MHz
144 MHz Ham	137 ~ 174 MHz
430 MHz Ham	420 ~ 470 MHz
AIR Band	108 ~ 137 MHz
Action Band 1	222 ~ 420 MHz
Action Band 2	800 ~ 999 MHz

Operation

FREQUENCY NAVIGATION

The **VX-5R** will initially be operating in the “VFO” mode, as just described. This is a channelized system which allows free tuning throughout the currently-selected operating band. You can confirm that you are in the VFO mode by looking in the upper-left-hand corner of the display; if you see “Va” (which stands for “VFO-A”) and/or “Vb” (VFO-B) along the left edge of the LCD, then you are in the VFO mode.

Three basic frequency navigation methods are available on the **VX-5R**:

1. Tuning Dial

Rotation of the **DIAL** allows tuning in the pre-programmed steps established for the current operating band. Clockwise rotation of the **DIAL** causes the **VX-5R** to be tuned toward a *higher* frequency, while counter-clockwise rotation will *lower* the operating frequency. If you press the **[F/W]** key momentarily, *then* rotate the **DIAL**, frequency steps of 1 MHz will be selected. This feature is extremely useful for making rapid frequency excursions over the wide tuning range of the **VX-5R**.

2. Direct Keypad Frequency Entry

The desired operating frequency may be entered directly from the keypad.

The operating mode will automatically be set once the new frequency is entered via the keypad.

To enter a frequency from the keypad, just press the numbered digits on the keypad in the proper sequence. There is no “decimal point” key on the **VX-5R**, so if the frequency is below 100 MHz (e.g. 15.150 MHz), any required leading zeroes *must* be entered.

Examples:

To enter 146.520 MHz, press

To enter 15.255 MHz, press

To enter 1.250 MHz (1250 kHz), press

To enter 0.950 MHz (950 kHz), press

3. Scanning

From the VFO mode, press and hold in the **[VFO(DW)SC]** key for one second.

The **VX-5R** will begin scanning toward a higher frequency, and will stop when it receives a signal strong enough to break through the Squelch threshold. The **VX-5R** will then hold on that frequency according to the setting of the “RESUME” mode (Menu #12). See page 63 for details.

If you wish to reverse the direction of the scan (i.e. toward a *lower* frequency, instead of a higher frequency), just rotate the **DIAL** one click in the counter-clockwise direction while the **VX-5R** is scanning. The scanning direction will be reversed. To revert to scanning toward a *higher* frequency once more, rotate the **DIAL** one click clockwise.

TRANSMISSION

Once you have set up an appropriate frequency inside one of the three Amateur bands on which the **VX-5R** can transmit (50 MHz, 144 MHz or 430 MHz), you're ready to transmit. These are the most basic steps; more advanced aspects of transmitter operation will be discussed later.

① To transmit, press the **PTT** switch, and speak into the front panel microphone (located in the upper right-hand corner of the speaker grille) in a normal voice level. The “**TX**” LED on top of the radio will glow Red during transmission.

② To return to the receive mode, release the **PTT** switch.

During transmission, the relative power level will be indicated on the LCD. Full power (5 Watts) is indicated by eight arrows below the frequency display. The three “Low Power” levels (L1, L2, and L3) are indicated by two, four, or six arrows, respectively. Additionally, the “L” icon will appear at the bottom of the display, followed by one, two, or three bars.



If you're just talking to friends in the immediate area, you'll get much longer battery life by switching to Low Power operation. To do this, just press the [TX PO(LOCK)] key so that the “L” icon appears at the bottom of the display. And don't forget, always have an antenna connected when you transmit.

Transmission is not possible on any operating bands other than the 50 MHz, 144 MHz, and 430 MHz bands.

AM BROADCAST RECEPTION

The **VX-5R** includes provision for reception of AM broadcasts, either on the standard medium-wave (MW) broadcast band, or on the shortwave bands up to 16 MHz.

① Press the [VFO(DW)SC] key repetitively until you see a frequency in the frequency range desired. The MW coverage is 0.5 MHz to 1.8 MHz, while the shortwave broadcast coverage is 1.8 MHz to 16 MHz. In either case, the operating mode (displayed on the right edge of the LCD) should be shown as being “AM.”

② Be sure that the **VX-5R** is set to the VFO mode (either “Va” or “Vb” will be visible at the left side of the display).

③ Rotate the **DIAL** to tune across the broadcast band.

④ You may also use the keypad to enter frequencies directly. This method will be quicker for changing from the 49-meter broadcast band to the 31-meter band, for example.



If the operating mode is not correct, you may need to adjust the setting of Menu #36 (RX MODE). See page 67 for details.

Operation

AM AIRCRAFT RECEPTION

Reception of AM signals in the aeronautical band (108-137 MHz) is similar to that described in the previous section.

- ① Press the **[BAND(SET)AR]** key repetitively until you see a frequency in the aeronautical band.
- ② Be sure that the **VX-5R** is set to the VFO mode (either “Va” or “Vb” will be visible at the left side of the display), and that “AM” is shown as the operating mode.
- ③ Rotate the **DIAL** to tune across the aeronautical band.
- ④ You may also use the keypad to enter frequencies directly. Remember that frequencies quoted by aircraft operators may be abbreviated, and that the “5” at the end of a frequency may be dropped. Since aeronautical channels are assigned in 25-kHz steps, therefore, a frequency announced as “thirty-two, forty-two” corresponds to an operating frequency of **132.425** MHz.

FM BROADCAST/TV AUDIO RECEPTION

The **VX-5R** also includes provision for reception in the FM broadcast band, utilizing a wide-bandwidth filter which provides excellent fidelity.

To Activate FM Broadcast Reception

- ① Press the **[BAND(SET)AR]** key repetitively until a frequency in the FM broadcast band appears on the display. The total frequency range included in the “FM” band is 59-108 MHz.
- ② Be sure you are in the VFO mode (press the **[VFO(DW)SC]** key if not), and that W-FM (Wide-bandwidth FM) is indicated as the operating mode.
- ③ Rotate the **DIAL** to select the desired station. The default synthesizer steps for the W-FM mode are 100 kHz/step.

To Activate VHF or UHF TV Audio Reception

- ① Press the **[BAND(SET)AR]** key repetitively until a frequency in the VHF or UHF TV bands appears on the LCD.
- ② Be sure you are in the VFO mode (press the **[VFO(DW)SC]** key if not).
- ③ Rotate the **DIAL** to select the desired station.



Remember that the Wide-FM Squelch setting may be made independently from the Narrow-FM setting, using Menu #02. See page 61.

WEATHER BROADCAST RECEPTION

The **VX-5R** includes a unique feature which allows reception of weather broadcasts in the 160-MHz frequency range. Ten standard Weather Broadcast channels are pre-loaded into a special memory bank.

To listen to a Weather Broadcast Channel:

- ① Press and hold in the **[0(SQL)WX]** key for one second to recall the Weather Broadcast channels.
- ② Turn the **DIAL** knob to select the desired Weather Broadcast channel.
- ③ If you wish to check the other channels for activity by scanning, just press and hold the **[MR(SK)SC]** key for one second.
- ④ To exit to normal operation, again press and hold in the **[0(SQL)WX]** key for one second. Operation will return to the VFO or Memory channel you were operating on before you began Weather Broadcast operation.



You can also append an alpha-numeric “Tag” (label) to a Weather Broadcast channel. See page 44.

Channel	Frequency	Channel	Frequency	Channel	Frequency	Channel	Frequency
WX 1	162.550 MHz	WX 4	162.425 MHz	WX 7	162.525 MHz	WX 10	163.275 MHz
WX 2	162.400 MHz	WX 5	162.450 MHz	WX 8	161.650 MHz		
WX 3	162.475 MHz	WX 6	162.500 MHz	WX 9	161.775 MHz		

Operation

KEYPAD/LCD ILLUMINATION

Your **VX-5R** includes a reddish illumination lamp which aids in nighttime operation. The red illumination yields clear viewing of the display in a dark environment, with minimal degradation of your night vision. Three options for activating the lamp are provided:

- KEY Mode: Pressing any key causes the lamp to provide illumination for 5 seconds, after which the lamp will automatically shut off.
- 5 SEC Mode: Pressing the **LAMP** switch momentarily causes the lamp to provide illumination for 5 seconds, after which the lamp will automatically shut off.
- TOGGLE Mode: Pressing the **LAMP** switch momentarily “Toggles” the lamp on and off. The lamp will stay illuminated until you press the **LAMP** switch once more.

Here is the procedure for setting up the Lamp mode:

- ① You first need to enter the “Set” (menu) mode. Press the **[F/W]** key, then immediately press the **[BAND(SET)AR]** key (just below the **[F/W]** key) to activate the Set mode.
- ② Now rotate the **DIAL** to select Menu Item #25 (“LAMP MODE•E).
- ③ Press the **[BAND(SET)AR]** key to enable modification of the current setting.
- ④ Next, rotate the **DIAL** to select one of the three modes described above.
- ⑤ When you have made your choice, press the **PTT** key to save the new setting for Menu Item #25. The transceiver will now return to normal operation.



*The 5 SEC mode provides the greatest battery conservation, as it allows activation of the lamp only when you press the **LAMP** switch.*

*If you press and hold in the **LAMP** key for one second, the lamp will remain illuminated until you press the **LAMP** switch once more (no time limit).*

NOTE

Advanced Operation



Now that you've mastered the basics of VX-5R operation, let's learn more about some of the really neat features. . .

SETTING THE FREQUENCY DISPLAY IMAGE SIZE

VFO Mode

The VX-5R's display may be configured so that only VFO-A is displayed, or (alternatively) it may be set for display (in smaller characters) of the Main (A or B) *and* Sub VFOs. As a third option, The Main VFO (only) may be displayed in small characters.

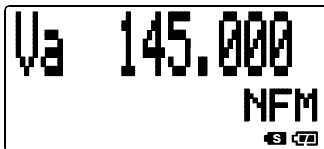

If the display currently shows the operating frequency in large characters (see the illustration), press and hold in the [1(TN)FRQ] key for one second to change the display to indication of both the Main and Sub VFOs. Press and hold in the [1(TN)FRQ] key for one second *again* to make the Sub VFO frequency disappear.

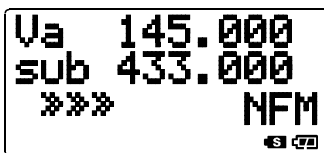

If the display currently shows the operating frequency in small characters, (displaying one or both VFO frequencies), press and hold in the [4(MG)DSP] key for one second to cause the display to double the size of the Main VFO frequency. The Sub VFO frequency will disappear.

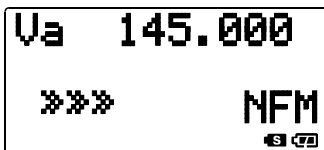

If you again press and hold in the [4(MG)DSP] key for one second, the LCD will revert to small-character display of the operating frequency; one or both VFOs will be shown, depending on how the display was set up per the preceding paragraph.

Memory Mode

When operating in the Memory mode (see page 42), pressing the [4(MG)DSP] key for one second causes the LCD to "toggle" between display of the current memory's frequency *only* (large characters) or the current memory's frequency on the top line *and* the memory channel number on the second line.

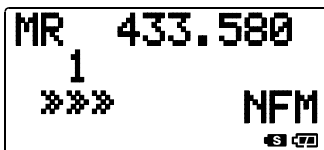
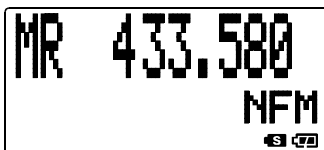

VFO SPLIT MODE

For working on repeaters with odd splits, or communicating with astronauts on orbiting space vehicles, it may be necessary to use non-standard splits between the receive and transmit frequency. If the application is infrequent enough not to warrant the dedication of a memory channel for this purpose, the “VFO Split” mode may be used. Here is the procedure:

- ① Set the **VX-5R** for display of both the Main and Sub VFOs, per the preceding section.
- ② Press the VFO key, as needed, to select VFO-A. Set VFO-A for the receiving frequency (for example, 437.950 MHz).
- ③ Now press the **[VFO(DW)SC]** key, and set VFO-B for the desired transmit frequency (e.g. 435.750 MHz).
- ④ Press the **[VFO(DW)SC]** key once more to re-establish VFO-A as the “Main” (receive) VFO.
- ⑤ Press the **[FW]** key, then press the **[BAND(SET)AR]** key to enter the Set mode.
- ⑥ Rotate the **DIAL** to select Menu #09 (“VFO SPLIT”).
- ⑦ Press the **[BAND(SET)AR]** key to enable activation of the VFO Split feature.
- ⑧ Rotate the **DIAL** one click to change the setting of this Menu item to ON. Press the **PTT** key once to exit to Split VFO operation. You will notice the “[+][–]” indicator on the display, which signifies Split operation.
- ⑨ You will now be operating in a Split mode. When you press the **PTT** key to transmit, you will observe that VFO-A and VFO-B will reverse positions. If you need to modify the VFO-B (transmit) frequency (for Doppler Shift correction, etc.), just press the **[VFO(DW)SC]** key, then make the necessary change, then press **[VFO(DW)SC]** key once more to restore VFO-A to the “receive VFO” position.
- ⑩ When you have finished with Split operation, re-enter the Set mode, and set Menu #09 to OFF.



A split frequency pair set up via the VFO Split feature cannot be stored directly into memory. You can, however, store odd frequency pairs using a different (slightly simpler) procedure. See page 42.

Advanced Operation

VFO LINKING

For split operation on the Amateur bands, the VFO Link feature may be useful.

- ① Set up VFO Split operation, as just described.
- ② Set VFO-A and VFO-B to the same Amateur band (e.g. 430 MHz).
- ③ While in the Set mode (used to set up Split operation), rotate the **DIAL** to select Menu #5 (“VFO”). This Menu item determines whether VFO tuning will be limited to the current band “BAND” or allowed to roam freely band-to-band “ALL”.
- ④ If the current setting is “ALL”, press the **[BAND(SET)AR]** key to enable modification of the “VFO” Menu item, then rotate the **DIAL** to set this Menu selection to “BAND.” Now press **[BAND(SET)AR]** once more.
- ⑤ Rotate the **DIAL** to select Menu #10 (“VFO LINK”).
- ⑥ Press the **[BAND(SET)AR]** key to enable activation of the VFO Link feature.
- ⑦ Rotate the **DIAL** to set this Menu selection to ON.
- ⑧ Press the **PTT** key to save the new setting and exit to Linked/Split VFO operation.

As you rotate the **DIAL**, you will observe that both VFO frequencies are changing together. When you are done with this operating mode, re-enter the Set mode, and set Menu #10 to OFF.



The VFO Link feature requires that (1) VFO-A and VFO-B be set to same band, (2) Menu #5 (“VFO”) must be set to “BAND.” In other words, the VFO Link feature cannot be activated if VFO-A and VFO-B are not set to the same band, or if Menu #5 (“VFO”) is set to “ALL.”

CHANGING THE CHANNEL STEPS

The **VX-5R**'s synthesizer provides the option of utilizing channel steps of 5/9/10/12.5/15/20/25/50/100 kHz per step, any number of which may be important to your operating requirements. The **VX-5R** is set up at the factory with different default steps on each operating band which probably are satisfactory for most operation. However, if you need to change the channel step increments, the procedure to do so is very easy.

- ① Press the **[FW]** key, then immediately press the **[7(ST)TMP]** key. This provides a short-cut to Menu Item #11 (“VFO STEP”).
- ② Rotate the **DIAL** to select the new channel step size.
- ③ Press the **PTT** key to save the new setting and exit to normal operation.



5 kHz steps are not available on the 50 MHz, “ACT 1,” and “ACT 2” bands; Use 25 kHz steps to load the 52.525 MHz Simplex Channel into a memory register, then switch to 10 kHz steps for tuning or scanning of other 6-meter frequencies. 9 kHz steps are not available, on the “USA” version, on any band.

You may also use the “Set” mode (Menu #11) to change the channel steps. See page 63 for details.

CHANGING THE OPERATING MODE

The **VX-5R** provides for automatic mode changing when the radio is tuned to different operating frequencies. However, should an unusual operating situation arise in which you need to change between the available operating modes (FM-Narrow, FM-Wide, and AM), here is the procedure for doing so:

- ① Press the **[FW]** key, then immediately press the **[BAND(SET)AR]** key to activate the Set mode.
- ② Rotate the **DIAL** to select Menu Item #36 (“RX MODE”).
- ③ Press the **[BAND(SET)AR]** key to enable modification of the current setting.
- ④ Now rotate the **DIAL** to select a new operating mode. The available selections are:
 - AUTO : Automatic mode setting per default values.
 - N-FM: Narrow-bandwidth FM (used for voice communication)
 - W-FM: Wide-bandwidth FM (used for high-fidelity broadcasting)
 - AM: Amplitude Modulation
- ⑤ Press the **PTT** key to save the new setting and exit to normal operation.



Unless you have a compelling reason to do so, leave the Automatic Mode Selection feature on so as to save time and trouble when changing bands. If you make a mode change for a particular channel or station, you can always store that one channel into memory, as the mode setting will be memorized along with the frequency information.

Default modes					
0.5-1.8 MHz (BC Band)	AM	137-174 MHz (2m Ham)	N-FM	335-420 MHz (Action Band 1)	N-FM
1.8-16 MHz (SW Band)	AM	174-222 MHz (VHF-TV)	W-FM	420-470 MHz (70cm Ham)	N-FM
48-59 MHz (6m Ham)	N-FM	222-250 MHz (Action Band1)	AM	470-729 MHz (UHF-TV)	W-FM
59-108 MHz (FM BC)	W-FM	250-255 MHz (Action Band1)	N-FM	800-999 MHz (Action Band 2)	N-FM
108-137 MHz (Air Band)	AM	255-335 MHz (Action Band1)	AM		

Advanced Operation

REPEATER OPERATION

Repeater stations, usually located on mountaintops or other high locations, provide a dramatic extension of the communication range for low-powered hand-held or mobile transceivers. The **VX-5R** includes a number of features which make repeater operation simple and enjoyable.

Repeater Shifts

Your **VX-5R** has been configured, at the factory, for the repeater shifts customary in your country. For the 50 MHz band, this usually will be 1 MHz, while the 144 MHz shift will be 600 kHz; on 70 cm, the shift may be 1.6 MHz, 7.6 MHz, or 5 MHz (USA version).

Depending on the part of the band in which you are operating, the repeater shift may be either downward (“-”) or upward (“+”), and one of these icons will appear at the bottom of the LCD when repeater shifts have been enabled.

Automatic Repeater Shift (ARS)

The VX-5R provides a convenient Automatic Repeater Shift feature, which causes the appropriate repeater shift to be automatically applied whenever you tune into the designated repeater sub-bands in your country. These sub-bands are shown below.

If the ARS feature does not appear to be working, you may have accidentally disabled it. To re-enable ARS:

- ① Press the **[F/W]** key, then immediately press the **[BAND(SET)AR]** key to enter the Set mode.
- ② Rotate the **DIAL** to select Menu Item #06 (“ARS”).
- ③ Press the **[BAND(SET)AR]** key to enable modification of the current setting.
- ④ Now rotate the **DIAL** to select “ON” (to enable Automatic Repeater Shift).
- ⑤ Press the **PTT** key to save the new setting and exit to normal operation.

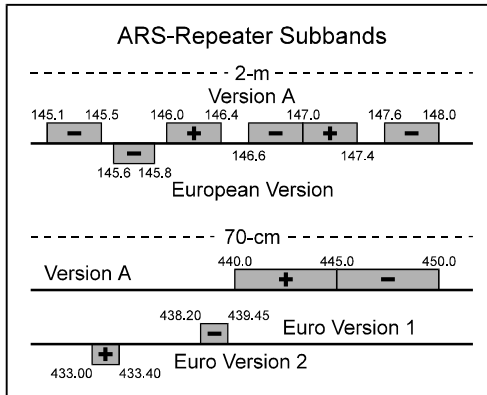

REPEATER OPERATION

Manual Repeater Shift Activation

If the ARS feature has been disabled, or if you need to set a repeater shift other than that established by the ARS, you may set the direction of the repeater shift manually.

To do this, press the [F/W] key, then press the [6(RP)ONT] key. This provides a “shortcut” to Menu #07 (“RPT SHIFT”). Rotate the **DIAL**, and you will see that the “-” or “+” icon appears at the bottom of the LCD (when no icon is present, “Simplex” operation - transmit and receive on the same frequency - has been selected, and the LCD will indicate “SIMP” in this case).

When the desired shift direction has been selected, press the **PTT** key momentarily to save your new setting and exit.

Changing the Default Repeater Shifts

If you travel to a different country, you may need to change the default repeater shift so as to ensure compatibility with local operating requirements.

To do this, follow the procedure below:

- ① Set the **VX-5R** to the band on which you wish to change the default repeater shift.
- ② Press the [F/W] key, then immediately press the [BAND(SET)AR] key to enter the Set mode.
- ③ Rotate the **DIAL** to select Menu Item #08 (“SHIFT”).
- ④ The current shift will now be displayed on the LCD. Press the [BAND(SET)AR] key then rotate the **DIAL** to select the new repeater shift magnitude.
- ⑤ Press the **PTT** key momentarily to save the new setting and exit.



If you just have one “odd” split that you need to program, don’t change the “default” repeated shifts using Menu Item #08! Enter the transmit and receive frequencies separately, as shown on page 42.

*When setting a large repeater shift (e.g. 5.0 MHz for 440 MHz), remember that you can tune in 1 MHz steps by pressing [F/W], then rotating the **DIAL**.*

Checking the Repeater Uplink (Input) Frequency

It often is helpful to be able to check the uplink (input) frequency of a repeater, to see if the calling station is within direct (“Simplex”) range.

To do this, press the [F/W] key then **MONI** key. Alternatively, if Menu Item #24 (“HOME/REV”) has been set to “REV”, you may just press the [HM/RV(EMG)] key momentarily. To return to the normal uplink/downlink frequency relationship, repeat this step.

Advanced Operation

CTCSS OPERATION

Many repeater systems require that a very-low-frequency audio tone be superimposed on your FM carrier in order to activate the repeater. This helps prevent false activation of the repeater by radar or spurious signals from other transmitters. This tone system, called “CTCSS” (Continuous Tone Coded Squelch System), is included in your **VX-5R**, and is very easy to activate.



CTCSS setup involves two actions: setting the Tone Frequency and then setting of the Tone Mode. These actions are set up by using the [1(TN)FRQ] and [2(CD)TAG] keys, or Menu Items #29 and #30.

- ① Press the [FW] key, then immediately press the [1(TN)FRQ] key. This provides a “short-cut” to Menu #29 (“SQL TYPE”).
- ② Rotate the **DIAL** so that “TONE” appears on the display; this activates the CTCSS Encoder, which allows repeater access.



*You may notice an additional “DCS” icon appearing while you rotate the **DIAL** in this step. We’ll discuss the Digital Code Squelch system shortly.*

- ③ Rotation of the **DIAL** in step ② above will occasionally cause “SQL” to appear adjacent to the “TONE” icon. When “TONE SQL” appears, this means that the Tone SQuELch system is active, which mutes your **VX-5R**’s receiver until it receives a call from another radio sending out a matching CTCSS tone. This can help keep your radio quiet until a specific call is received, which may be helpful while operating in congested areas.
- ④ When you have made your selection of the CTCSS tone mode, press the [BAND(SET)AR] key.
- ⑤ Now rotate the **DIAL** one click clockwise to select Menu #30 (“TONE SET”). This Menu selection allows setting of the CTCSS tone frequency to be used.
- ⑥ Press the [BAND(SET)AR] key to enable adjustment of the CTCSS frequency.
- ⑦ Rotate the **DIAL** until the display indicates the Tone Frequency you need to be using (ask the repeater owner/operator if you don’t know the tone frequency).
- ⑧ Press the [2(CD)TAG] key to save the new settings and exit to normal operation.



*Some repeaters may or may not re-transmit a CTCSS tone - some systems just use CTCSS to control access to the repeater, but don’t pass it along when transmitting. If the **BUSY LED** glows green, but the **VX-5R** is not passing audio, repeat steps ① through ③ above, but rotate the **DIAL** so that “SQL” disappears - this will allow you to hear all traffic on the channel being received.*

CTCSS TONE FREQUENCY (Hz)							
67.0	69.3	71.9	74.4	77.0	79.7	82.5	85.4
88.5	91.5	94.8	97.4	100.0	103.5	107.2	110.9
114.8	118.8	123.0	127.3	131.8	136.5	141.3	146.2
151.4	156.7	162.2	167.9	173.8	179.9	186.2	192.8
203.5	210.7	218.1	225.7	233.6	241.8	250.3	-

Advanced Operation

DCS OPERATION

Another form of tone access control is Digital Code Squelch, or DCS. It is a newer, more advanced tone system which generally provides more immunity from false paging than does CTCSS. The DCS Encoder/Decoder is built into your **VX-5R**, and operation is very similar to that just described for CTCSS. Your repeater system may be configured for DCS; if not, it is frequently quite useful in Simplex operation if your friend(s) use transceivers equipped with this advanced feature.



*Just as in CTCSS operation, DCS requires that you set the **Tone Mode** to **DCS** and that you select a tone code.*

- ① Press the **[F/W]** key, then immediately press the **[1(TN)FRQ]** key. This provides a “short-cut” to Menu #29 (“SQL TYPE”).
- ② Rotate the **DIAL** until “DCS” appears in the upper right-hand area of the LCD; this activates the DCS Encoder/Decoder.
- ③ Now press the **[BAND(SET)AR]** key, and rotate the **DIAL** to select Menu #31 (“DCS SET”).
- ④ Press the **[BAND(SET)AR]** key to enable adjustment of the DCS Code.
- ⑤ Rotate the **DIAL** to select the desired DCS Code (a three-digit number). Ask the repeater owner/operator if you don’t know DCS Code; if you are working simplex, just set up the DCS Code to be the same as that used by your friend(s).
- ⑥ When you have made your selection, press the **[2(CD)TAG]** key to save the new settings and exit to normal operation.



Remember that the DCS is an Encode/Decode system, so your receiver will remain muted until a matching DCS code is received on an incoming transmission. Switch the DCS off when you’re just tuning around the band!

DCS CODE																							
023	025	026	031	032	036	043	047	051	053	054	065	071	072	073	074	114	115	116	122	125			
131	132	134	143	145	152	155	156	162	165	172	174	205	212	223	225	226	243	244	245	246			
251	252	255	261	263	265	266	271	274	306	311	315	325	331	332	343	346	351	356	364	365			
371	411	412	413	423	431	432	445	446	452	454	455	462	464	465	466	503	506	516	523	526			
532	546	565	606	612	624	627	631	632	654	662	664	703	712	723	731	732	734	743	754				

Advanced Operation

TONE SEARCH SCANNING

In operating situations where you don't know the CTCSS or DCS tone being used by another station or stations, you can command the radio to *listen* to the incoming signal and *scan* in search of the tone being used. Two things must be remembered in this regard:

- You must be sure that your repeater uses the same tone type (CTCSS vs. DCS).
- Some repeaters do not pass the CTCSS tone; you may have to listen to the station(s) transmitting on the repeater *uplink* (input) frequency in order to allow Tone Search Scanning to work.

To scan for the tone in use:

- ① Set the radio up for either CTCSS or DCS Decoder operation (see the previous discussion). In the case of CTCSS, "T SQ" will appear on the display; in the case of DCS, "DCS" will appear on the display.
- ② Press the **[F/W]** key, then immediately press the **[2(CD)TAG]** key to select the "TONE SET" Menu item (when TONE SQL is selected) or "DCS SET" (during DCS operation).
- ③ Press and hold in the **[VFO(DW)SC]** key to start scanning for the incoming CTCSS or DCS tone/code.
- ④ When the radio detects the correct tone or code, it will halt on that tone/code, and audio will be allowed to pass. Press the **[BAND(SET)AR]** key to lock in that tone/code, then press **PTT** to exit to normal operation.



If the Tone Scan feature does not detect a tone or code, it will continue to scan indefinitely. When this happens, it may be that the other station is not sending any tone. You can press the PTT switch to halt the scan at any time.

*You also can press the **MONI** key during Tone Scanning to listen to the (muted) signal from the other station. When you release the **MONI** key, Tone Scanning will resume after about a second.*

Tone Scanning works either in the VFO or Memory modes.

CTCSS/DCS BELL OPERATION

During CTCSS Decode or DCS operation, you may set the **VX-5R** up such that a ringing “bell” sound alerts you to the fact that a call is coming in. Here is the procedure for activating the Bell will ring in accordance with this programming.

- ① Set the transceiver up for CTCSS Decode (“TONE SQL”) or DCS operation, as described previously.
- ② Adjust the operating frequency to the desired channel.
- ③ Press the **[FW]** key, then press the **[BAND(SET)AR]** key to activate the Set mode.
- ④ Rotate the **DIAL** to select Menu Item #22 (“BELL”).
- ⑤ Press the **[BAND(SET)AR]** key to enable adjustment of the Bell ringer.
- ⑥ Rotate the **DIAL** to set the desired number of rings of the Bell. The available choices are 1, 3, 5, or 8 rings, REPEAT (continuous ringing), or OFF.
- ⑦ Press the **PTT** key momentarily to save the new setting and exit to normal operation.

When a station calls you whose transceiver is sending a CTCSS tone or DCS code which matches that set into your Decoder, the Bell will ring in accordance to this programming.

TONE CALLING (1750 Hz)

If the repeaters in your country require a 1750-Hz burst tone for access (typically in Europe), you can set the **MONI** key to serve as a “**TONE CALL**” switch instead. To change the configuration of this switch, we again use the Menu to help us.

- ① Press the **[FW]** key, then press the **[BAND(SET)AR]** key to enter the Set mode.
- ② Rotate the **DIAL** to select Menu Item #23 (“MON/T-CAL”).
- ③ Press the **[BAND(SET)AR]** key to enable adjustment of this Menu item.
- ④ Rotate the **DIAL** to select “T-CALL” on the display.
- ⑤ Press the **PTT** key to save the new setting and exit.
- ⑥ To access a repeater, press and hold in the **MONI** key for the amount of time specified by the repeater owner/operator. The transmitter will automatically be activated, and a 1750-Hz audio tone will be superimposed on the carrier. Once access to the repeater has been gained, you may release the **MONI** key, and use the **PTT** key for activating the transmitter.

Advanced Operation

CHANGING THE TRANSMITTER POWER LEVEL

You can select between a total of four transmitter power levels on your **VX-5R**. The exact power output will vary somewhat, depending on the voltage supplied to the transceiver. With the standard **FNB-80LI** Battery Pack, the power output levels available are:

ICONS			
NONE (HIGH)	LIII (L3)	LI (L2)	LI (L1)
5 W (50/145 MHz) 4.5W (430 MHz)	2.5 W	1 W	0.3 W

To change the power level:

- ① The default setting for the power output is “High;” in this configuration, the LCD shows no indication of the power output level. Pressing the **[TX PO(LOCK)]** key causes the “Low Power” icon to appear, followed by one, two, or three vertical bars, indicating power levels “L1,” “L2,” or “L3.”
- ② Pressing the **[TX PO(LOCK)]** key until the “Low Power” icon disappears will restore High Power operation.



*The **VX-5R** is smart! You can set up Low power on one band (like UHF), while leaving VHF on High power, and the radio will remember the different settings on each band. And when you store memories, you can store High and Low power settings separately in each memory, so you don't waste battery power when using very close-in repeaters!*

CHANGING THE TX DEVIATION LEVEL

In many areas of the world, channel congestion has required that operating channels be closely spaced. In such operating environments, it often is required that operators use reduced deviation levels, so as to reduce the potential for interference to users on adjacent channels. The **VX-5R** includes a simple method of accomplishing this:

- ① Press the **[F/W]** key, then press the **[BAND(SET)AR]** key to enter the Set mode.
- ② Rotate the **DIAL** to select Menu Item #38 (“HALF DEV”).
- ③ Press the **[BAND(SET)AR]** key to enable adjustment of this Menu item.
- ④ Rotate the **DIAL** to change this setting to ON. In this configuration (HALF DEVIATION active), the transmitter's deviation will be approximately ± 2.5 kHz.
- ⑤ When you have made your selection, press the **PTT** key to save the new setting and exit to normal operation.



The “normal” setting for the deviation (when this Menu item is set to OFF) is ± 5 kHz.

TRANSMITTER TIME-OUT TIMER (TOT)

The TOT feature provides a safety switch which limits transmission to a pre-programmed value. This will promote battery conservation by not allowing you to make excessively-long transmissions, and in the event of a stuck **PTT** switch (perhaps if the radio or a Speaker/Mic is wedged between car seats) it can prevent interference to other users as well as battery depletion. As configured at the factory the TOT feature is set to OFF, and here is the procedure for activating it:

- ① Press the **[FW]** key, then press the **[BAND(SET)AR]** key to enter the Set mode.
- ② Rotate the **DIAL** to select Menu Item #26 (“TOT”).
- ③ Press the **[BAND(SET)AR]** key to enable adjustment of this Menu item.
- ④ Rotate the **DIAL** to set the Time-Out Timer to the desired “Maximum TX” time (1 minute, 2.5 minutes, 5 minutes, or 10 minutes).
- ⑤ Once you’ve made the selection you wish to use, press the **PTT** key to save the new setting and exit to normal operation.



Since brief transmissions are the mark of a good operator, try setting up your radio’s TOT feature for a maximum transmission time of 1 minute. This will significantly improve battery life, too!

BUSY CHANNEL LOCK-OUT (BCLO)

The BCLO feature prevents the radio’s transmitter from being activated *if* a signal strong enough to break through the “Noise” squelch is present. On a frequency where stations using different CTCSS or DCS codes may be active, BCLO prevents you from disrupting their communications accidentally (because your radio may be muted by its own Tone Decoder). The default setting for the BCLO is OFF, and here is how to change that setting:

- ① Press the **[FW]** key, then press the **[BAND(SET)AR]** key to enter the Set mode.
- ② Rotate the **DIAL** to select Menu Item #27 (“BCLO”).
- ③ Press the **[BAND(SET)AR]** key to enable adjustment of this Menu item.
- ④ Rotate the **DIAL** to set the BCLO feature to the “ON” position.
- ⑤ Press the **PTT** key to save the new setting and resume normal operation.

Advanced Operation

RECEIVE BATTERY SAVER SETUP

An important feature of the **VX-5R** is its Receive Battery Saver, which “puts the radio to sleep” for a time interval, periodically “waking it up” to check for activity. If somebody is talking on the channel, the **VX-5R** will remain in the “active” mode, then resume its “sleep” cycles. This feature significantly reduces quiescent battery drain, and you may change the amount of “sleep” time between activity checks using the Menu System:

- ① Press the **[F/W]** key, then press the **[BAND(SET)AR]** key to enter the Set mode.
- ② Rotate the **DIAL** to select Menu Item #14 (“RX SAVE”).
- ③ Press the **[BAND(SET)AR]** key to enable adjustment of this Menu item.
- ④ Rotate the **DIAL** to select the desired “sleep” duration. The selections available are 200 ms, 300 ms, 500 ms, 1 second, and 2 seconds, or OFF. The default value is 200 ms.
- ⑤ When you have made your selection, press the **PTT** key to save the new setting and exit to normal operation.



When you are operating on Packet, switch the Receive Battery Saver OFF, as the sleep cycle may “Collide” with the beginning of an incoming Packet transmission, causing your TNC not to receive the full data burst.

TX BATTERY SAVER

The **VX-5R** also includes a useful Transmit Battery Saver, which will automatically lower the power output level when the *last signal received* was very strong. For example, when you are in the immediate vicinity of a repeater station, there generally is no reason to use the full 5 Watts of power output in order to achieve full-quieting access to the repeater. With the Transmit Battery Saver, the automatic selection of Low Power operation conserves battery drain significantly.

To activate the Transmit Battery Saver:

- ① Press the **[F/W]** key, then press the **[BAND(SET)AR]** key to enter the Set mode.
- ② Rotate the **DIAL** to select Menu Item #15 (“TX SAVE”).
- ③ Press the **[BAND(SET)AR]** key to enable adjustment of this Menu item.
- ④ Rotate the **DIAL** so as to select ON (thus activating the Transmit Battery Saver).
- ⑤ When you have completed your selection, press the **PTT** key to save the new setting and exit to normal operation.

DISABLING THE BUSY/TX LED

Further battery conservation may be accomplished by disabling the **BUSY/TX** LED. Use the following procedure:

- ① Press the **[F/W]** key, then press the **[BAND(SET)AR]** key to enter the Set mode.
- ② Rotate the **DIAL** to select Menu Item #17 (“BUSY LED”).
- ③ Press the **[BAND(SET)AR]** key to enable adjustment of this Menu item.
- ④ Rotate the **DIAL** to set this Menu item to OFF (thus disabling the **BUSY/TX** LED).
- ⑤ Press the **PTT** key to save the new setting and exit to normal operation.

BATTERY UTILIZATION MONITOR

The **VX-5R** includes a timer circuit which can be used to monitor the elapsed time since your radio’s battery was most recently charged. This can serve as a handy method of anticipating when you will need to re-charge the battery.

To monitor the elapsed time since the timer was last reset, press and hold in the **[6(RP)ONT]** key. The display will now indicate the number of hours and minutes of Operating (Receive + Transmit) time (the display shows Receive Time **[Rhh:mm]** and Transmit time **[T hh:mm]** since you most recently turned the transceiver on).

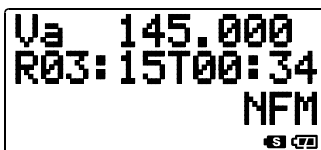

Ua 145.000
R03: 15T00:34
NFM
S V2

To reset the timer to “Zero” after charging the battery, press and hold in the **[F/W]** key, then press the **[6(RP)ONT]** key, *while the operating time is being displayed*; the timer will reset to indicate **[R00:00]** **[T00:00]**.

AUTOMATIC POWER-OFF (APO) FEATURE

The APO feature helps conserve battery life by automatically turning the radio off after a user-defined period of time within which there has been no dial or key activity. The available selections for the time before power-off are 0.5/1/3/5/8 hours, as well as APO Off. The default condition for the APO is OFF, and here is the procedure for activating it:

- ① Press the **[F/W]** key, then press the **[5(AP)ICO]** key to enter the Set mode at Menu #16 (“APO”).
- ② Rotate the **DIAL** to select the desired time period after which the radio will automatically shut down.
- ③ Once you have made your selection, press the **PTT** key to save the new setting and exit to normal operation.

Advanced Operation

AUTOMATIC POWER-ON FEATURE

The **VX-5R** also includes the capability to turn itself *on* after a programmed time interval.

- ① Press the **[F/W]** key, then press the **[BAND(SET)AR]** key to enter the Set mode.
- ② Rotate the **DIAL** to select Menu #40 (“ON TIMER”).
- ③ Press the **[BAND(SET)AR]** key to enable setting or the power-on interval.
- ④ Rotate the **DIAL** to select the desired time period after which the radio will automatically turn on.



Note that this is not the time of day when the radio will turn on; it is the number of hours and minutes until the radio turns on.

- ⑤ Once you have made your selection, press the **PTT** key to save the new setting and exit to normal operation.

KEYBOARD LOCKING

In order to prevent accidental frequency change or inadvertent transmission, various aspects of the **VX-5R**'s keys and switches may be locked out. The possible lockout combinations are:

KEY:	Just the front panel keys are locked out
DIAL:	Just the top panel DIAL is locked out
KEY + DIAL:	Both the DIAL and Keys are locked out
PTT:	The PTT switch is locked (TX not possible)
KEY + PTT:	Both the keys and PTT switch are locked out
DIAL + PTT:	Both the DIAL and PTT switch are locked out
ALL:	All of the above are locked out

To lock out some or all of the keys:

- ① Press the **[F/W]** key, then press the **[BAND(SET)AR]** key to enter the Set mode.
- ② Rotate the **DIAL** to select Menu Item #37 (“LOCK MODE”).
- ③ Press the **[BAND(SET)AR]** key to enable setting of the Lock mode (which defines which keys/functions are to be locked out).
- ④ Rotate the **DIAL** to choose between one of the locking schemes as outlined above.
- ⑤ Once you have made your selection, press the **PTT** key momentarily to save the new setting and resume normal operation.
- ⑥ To activate the locking feature, press the **[F/W]** key, then press the **[TX PO(LOCK)]** key. The “L” icon will appear on the LCD. To cancel keyboard locking, again press **[F/W]** key, followed by **[TX PO(LOCK)]** key.



*Even when “ALL” keys have been locked out, two keys actually are not locked out: the **[F/W]** key and the **[TX PO(LOCK)]** key remains available, so you can repeat step ⑥ above to disable the “Lock” mode.*

Advanced Operation

DISABLING THE KEYPAD BEEPER

If the keypad's Beeper creates an inconvenience (particularly when operating in a quiet room), it may easily be disabled.

- ① Press **[F/W]** then, press the **[9(BP)ALT]** key, to enter the Set mode at Menu #20 ("KEY BEEP").
- ② Rotate the **DIAL** to change the setting from ON to OFF.
- ③ When you have made your selection, press the **PTT** key to save the new setting and exit to normal operation.
- ④ If you wish to re-enable the Beeper, just repeat the above procedure, rotating the **DIAL** to select ON in step ② above.

CHECKING THE BATTERY VOLTAGE

The **VX-5R**'s microprocessor includes programming which will detect the battery type and measure the current battery voltage.

To check the battery condition, press and hold in the **[3(DT)VLT]** key for one second.

The "Sub VFO" display window will now be replaced by an indication of the battery type and the current DC voltage being supplied.

The displays include:

Lit: **FNB-80LI** is in use

Dry: **FBA-23** is in use

EXT: An external DC source is in use

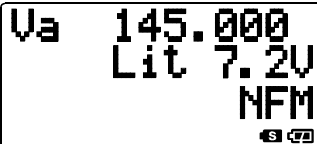

The LCD display shows the following information: "Va 145.000" on the top line, "Lit 7.2V" on the second line, "NFM" on the third line, and a small icon of a battery with a lightning bolt on the bottom right.

To return to normal operation, press and hold in the **[3(DT)VLT]** key for one second. If you were operating with the Main VFO field enlarged, press **[4(MG)DSP]** key instead.

TEMPERATURE DISPLAY

You can measure the current temperature inside the transceiver's case.

To do this, press and hold the **[7(ST)TMP]** key for one second. The display will now indicate the current temperature.

To return to normal operation, press and hold the **[7(ST)TMP]** key for one second. If you were operating with the Main VFO field enlarged, press **[4(MG)DSP]** key instead.

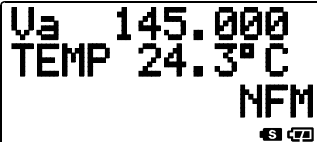

The LCD display shows the following information: "Va 145.000" on the top line, "TEMP 24.3°C" on the second line, "NFM" on the third line, and a small icon of a battery with a lightning bolt on the bottom right.

Advanced Operation

DTMF OPERATION

The **VX-5R**'s 16-button keypad allows easy DTMF dialing for Autopatch or repeater control purposes. Besides numerical digits [0] through [9], the keypad includes the [*] and [#] digits, plus the [A], [B], [C], and [D] tones often used for repeater control.

Manual DTMF Tone Generation

You can generate DTMF tones during transmission manually.

- ① Press the **PTT** switch to begin transmission.
- ② While transmitting, press the desired numbers on the keypad.
- ③ When you have sent all the digits desired, release the **PTT** key.

DTMF Autodialer

Eight DTMF Autodial memories are provided, allowing you to store telephone numbers for autopatch use. You can also store short autopatch access code streams so as to avoid having to send them manually.

Here is the DTMF Autodial storage procedure:

- ① Press the [F/W] key, then press the [BAND(SET)AR] key to enter the Set mode.
- ② Rotate the **DIAL** to select Menu Item #32 (“DTMF SET”).
- ③ Press the [BAND(SET)AR] key to enable adjustment of this Menu item.
- ④ Rotate the **DIAL** to select the DTMF Memory register into which you wish to store this DTMF string.
- ⑤ Press the [BAND(SET)AR] key to begin DTMF Memory entry into the selected register.
- ⑥ Key in the DTMF digits you wish to store into this register.
- ⑦ Press the **PTT** switch to save the setting. To store other numbers, repeat this process, using a different DTMF memory register.



*If you decide to over-write a previously-stored DTMF memory, and the new number is shorter than the original number, press **MONI** key twice to cancel out all the obsolete digits after the end of the new telephone number.*

To send the telephone number:

- ① Press [F/W], then the [3(DT)VLT] key to activate the DTMF Autodialer function.
- ② Press the **PTT** switch to begin transmission.
- ③ Press the numerical key ([1] through [9]) corresponding to the DTMF memory string you wish to send. Once the string begins, you may release the **PTT** key, as the transmitter will be held “on the air” until the DTMF string is completed.

EMERGENCY CHANNEL OPERATION

The **VX-5R** includes an “Emergency” feature which may be useful if you have someone monitoring on the same frequency as your transceiver’s **UHF** “Home” channel. See page 43 for details on setting the Home channel.

The “Emergency” feature is activated by pressing the **[HM/RV(EMG)]** key for one second.

When this is done, the radio (A) is placed on the UHF Amateur band Home channel, (B) emits a loud “Alarm” sound (the volume is controlled by the **VOLUME** knob), and (C) if you press the **PTT** key, this alarm sound will be transmitted.

Use this feature if you are out for a walk and want a quick way of alerting a family member as to a dangerous situation. The alarm sound may discourage an attacker and allow you to escape.



Be sure to arrange with a friend or family member to be monitoring on the same frequency, as there will be no identification sent via the Emergency alarm sound. And do not transmit the alarm tone except in a true emergency!

Advanced Operation

ARTS (AUTOMATIC RANGE TRANSPONDER SYSTEM)

The ARTS feature uses DCS signaling to inform both parties when you and another ARTS-equipped station are within communications range. This may be particularly useful during Search-and Rescue situations, where it is important to stay in contact with other members of your group.

Both stations must set up their DCS codes to the same code number, then activate their ARTS feature using the command appropriate for their radio. Alert ringers may be activated, if desired.

Whenever you push the **PTT**, or every 25 (or 15) seconds after ARTS is activated, your radio will transmit a signal which includes a (subaudible) DCS signal for about 1 second. If the other radio is in range, the beeper will sound (if enabled) and the display will show “IN RANGE” as opposed to the out of range display “OUT RANGE” in which ARTS operation begins.

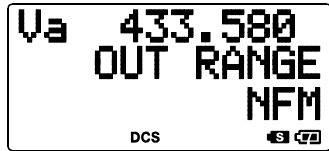
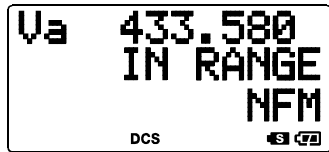

Whether you talk or not, the polling every 15 or 25 seconds will continue until you de-activate ARTS. Every 10 minutes, moreover, you can have your radio transmit your callsign via CW, so as to comply with identification requirements. When ARTS is de-activated, DCS will also be deactivated (if you were not using it previously in non-ARTS operation).

If you move out of range for more than one minute (four pollings), your radio will sense that no signal has been received, three beeps will sound, and the display will revert to “OUT RANGE.” If you move back into range, your radio will again beep, and the display will change back to the “IN RANGE” indication.

ARTS (AUTOMATIC RANGE TRANSPONDER SYSTEM)

During ARTS operation, your operating frequency will continue to be displayed, but no changes may be made to it or other settings; you must terminate ARTS in order to resume normal operation. This is a safety feature designed to prevent accidental loss of contact due to channel change, etc.

Here is how to activate ARTS:

Basic ARTS Setup and Operation

- ① Set your radio and the other radio(s) to the same DCS code number, per the discussion on page 27.
- ② Press and hold in the **[BAND(SET)AR]** key for one second. You will observe the “OUT RANGE” display on the LCD below the operating frequency. ARTS operation has now commenced.
- ③ Every 25 seconds, your radio will transmit a “polling” call to the other station. When that station responds with its own ARTS polling signal, the display will change to “IN RANGE” to confirm that the other station’s polling code was received in response to yours.
- ④ Press the **[BAND(SET)AR]** key again for one second to exit ARTS operation and resume normal functioning of the transceiver.



ARTS won't work if you have used the Lock feature to disable the PTT!

ARTS Polling Time Options

The ARTS feature may be programmed to poll every 25 seconds (default value) or 15 seconds. The default value provides maximum battery conservation, because the polling signal is sent out less frequently. To change the polling interval:

- ① Press the **[FW/]** key, then press the **[BAND(SET)AR]** key, to enter the Set mode.
- ② Rotate the **DIAL** to select Menu #19 (“ARTS ITVL”).
- ③ Press the **[BAND(SET)AR]** key to enable changing of this Menu item.
- ④ Rotate the **DIAL** to select the desired polling interval (15 or 25 seconds).
- ⑤ When you have made your selection, press the **PTT** key to save the new setting and exit to normal operation.

Advanced Operation

ARTS (AUTOMATIC RANGE TRANSPONDER SYSTEM)

ARTS Alert Beep Options

The ARTS feature allows two kinds of alert beeps (with the additional option of turning them off), so as to alert you to the current status of ARTS operation. Depending on your location and the potential annoyance associated with frequent beeps, you may choose the Beep mode which best suits your needs. The choices are:

- IN RANGE: The beeps are issued only when the radio first confirms that you are within range, but does not re-confirm with beeps thereafter.
- ALL: Every time a polling transmission is received from the other station, the alert beeps will be heard.
- OFF: No alert beeps will be heard; you must look at the display to confirm current ARTS status.

To set the ARTS Beep mode, use the following procedure:

- ① Press the **[F/W]** key, then press the **[BAND(SET)AR]** key, to enter the Set mode.
- ② Rotate the **DIAL** to select Menu #18 (“ARTS BEEP”).
- ③ Press the **[BAND(SET)AR]** key to enable changing of this Menu item.
- ④ Rotate the **DIAL** to select the desired ARTS Beep mode (see above).
- ⑤ When you have made your selection, press the **PTT** key to save the new setting and exit to normal operation.

ARTS (AUTOMATIC RANGE TRANSPONDER SYSTEM)

CW Identifier Setup

The ARTS feature includes a CW identifier, as discussed previously. Every ten minutes during ARTS operation, the radio can be instructed to send “**DE (your callsign) K**” if this feature is enabled. The callsign field may contain up to 8 characters.

Here’s how to program the CW Identifier:

- ① Press the **[F/W]** key, then press the **[BAND(SET)AR]** key, to enter the Set mode.
- ② Rotate the **DIAL** to select Menu #33 (“CW ID”).
- ③ Press the **[BAND(SET)AR]** key to enable changing of this Menu item.
- ④ Rotate the **DIAL** to set the CW ID function ON.
- ⑤ Press the **[BAND(SET)AR]** key once more to begin entry of the letters and numbers in your callsign.
- ⑥ Rotate the **DIAL** to select the first letter or number in your callsign. When the correct character has been selected, press the **[BAND(SET)AR]** key to move on to the next character.
- ⑦ Repeat step ⑥ as many times as necessary to complete your callsign, pressing **[BAND(SET)AR]** between each entry. Note that the “slant bar” (– • – •) is among the available characters, should you be a “portable” station.
- ⑧ To check the programming, before you exit, press the **[F/W]** key momentarily. You will hear the CW Identification message as you have programmed it.
- ⑨ When you have entered your entire callsign, press the **PTT** key to save the settings and exit to normal operation.



Note that the “DE” (–•• •) preceding your callsign is already programmed; you only need to program your callsign, and the “DE” will be appended at the time of transmission.

Memory Mode

The **VX-5R** provides a wide variety of memory system resources. These include:

- 220 “Standard” memory channels, numbered “1” through “220.”
- A HOME channel per band, allowing storage and quick recall of one prime frequency on each band.
- Ten sets of band-edge memories also known as “Programming Memory Scan” channels, labeled “L1/U1” through “L10/U10”.
- Five Memory Groups, labeled “MG1” through “MG5”. Each Memory Group can be assigned 24 channels from the “standard” memory channel bank.

MEMORY STORAGE

- ① Select the desired frequency, while operating in the VFO mode. Be sure to set up any desired CTCSS or DCS tones, as well as any desired repeater offset. The power level may also be set at this time, if you wish to store it.
- ② Press and hold the **[FW]** key for one second.
- ③ Within five seconds of releasing the **[FW]** key, rotate the **DIAL** to select the desired memory channel. The microprocessor will automatically select the next-available “free” channel (a memory register on which no data has been stored). If you see an Asterisk (*) by any channel number, it means that the channel currently has no data written on it (i.e. the channel is “free”).
- ④ Press the **[FW]** key once more to store the frequency into memory.
- ⑤ You still will be operating in the “VFO” mode, so you may now enter other frequencies, and store them into additional memory locations, by repeating the above process.

STORING INDEPENDENT TRANSMIT FREQUENCIES (“ODD SPLITS”)

All memories can store an independent transmit frequency, for operation on repeaters with non-standard shift. To do this:

- ① Store the receive frequency using the method already described under **MEMORY STORAGE** (it doesn’t matter if a repeater offset is active).
- ② Turn to the desired transmit frequency, then press and hold the **[FW]** key for one second.
- ③ Within five seconds of releasing the **[FW]** key, rotate the **DIAL** to select the same memory channel number as used in step ① above.
- ④ Press and hold the **PTT** switch then press the **[FW]** key once more momentarily (this does not key the transmitter).



Whenever you recall a memory which contains independently-stored transmit and receive frequencies, the “[+][–]” indication will appear in the display.

MEMORY RECALL

- ① While operating in the VFO mode, press the **[MR(SK)SC]** key. The “MR” indicator will show that you are now in the Memory Recall mode.
- ② Rotate the **DIAL** to select the desired channel.
- ③ To return to the VFO mode, press the **[VFO(DW)SC]** key.



*An easy way to recall memories is to key in the memory channel number, then press **[MR(SK)SC]**.*

For example, to recall memory channel #14, press  *.*

HOME CHANNEL MEMORY

A special one-touch “HOME” channel is available (one for each of the designated “VFO” bands) to allow quick recall of a favorite operating frequency on each band. Memory storage is simple to accomplish:

- ① Set Menu Item #24 (“HOME/REV”) to “HOME” if it is not already set to that option (see page 65).
- ② Select the desired frequency, while operating in the VFO mode. Be sure to set up any desired CTCSS or DCS tones, as well as any desired repeater offset. The power level may also be set at this time, if you like.
- ② Press and hold the **[F/W]** key for one second.
- ③ While the memory channel number is blinking, just press the **[HM/RV(EMG)]** key. The frequency and other data (if any) will now be stored in the special HOME channel register.
- ④ You may repeat this process on each of the other “VFO” bands.
- ⑤ To recall the HOME channel, press the **[HM/RV(EMG)]** key momentarily while operating in the VFO or MR mode. The HOME channel corresponding to the frequency range on which you are currently operating will automatically be selected (i.e. if you are operating on a memory channel in the Aviation band, the “Aviation Band Home Channel” will be selected).



Note that the UHF HOME channel is the one used during “Emergency” operation. See page 37 for details regarding this feature.

Memory Mode

LABELING MEMORIES

You may wish to append an alpha-numeric “Tag” (label) to a memory or memories, to aid in recollection of the channel’s use (such as a club name, etc.). This is easily accomplished using the Set mode.

- ① Recall the memory channel on which you wish to append a label.
- ② Press the **[F/W]** key, then press the **[BAND(SET)AR]** key, to enter the Menu mode.
- ③ Rotate the **DIAL** to select Menu #03 (“NAME SET”).
- ④ Press the **[BAND(SET)AR]** key momentarily to enable programming of the name tag.
- ⑤ Rotate the **DIAL** to select the first digit of the desired label. When you have made your selection, press the **[BAND(SET)AR]** key momentarily to move to the next character.
- ⑥ Repeat the previous step to program the remaining letters, numbers, or symbols of the desired label. A total of eight characters may be used in the creation of a label.
- ⑦ When you have completed the creation of the label, press the **PTT** key to save the label and exit.

During “MR” (Memory Recall) operation, press and hold in the **[2(CD)TAG]** key for one second to activate the alphanumeric Tag. Repeatedly pressing and holding in this key will toggle operation between “*Frequency only*” display and “*Frequency + Tag*” display.

MEMORY OFFSET TUNING

Once you have recalled a particular memory channel, you may easily tune off that channel, as though you were in the “VFO” mode.

- ① With the **VX-5R** in the “MR” (Memory Recall) mode, select the desired memory channel.
- ② Now press the **[MR(SKP)SC]** key momentarily. The “MR” indicator will be replaced by one which says “MT” (“Memory Tuning”).
- ③ Rotate the **DIAL**, as desired, to tune to a new frequency. The synthesizer steps selected for VFO operation on the current band will be the steps used during Memory Tuning.
- ④ If you wish to return to the *original* memory frequency, press the **[MR(SKP)SC]** key momentarily. The “MT” indicator will be replaced by “MR”.
- ⑤ If you wish to store a new frequency set during Memory Tuning, just press and hold in the **[F/W]** key for one second, per normal memory storage procedure. The microprocessor will automatically set itself to the next-available clear memory location, and you then press **[F/W]** again to lock in the new frequency.



*If you want to replace the original memory contents with those of the new frequency, be sure to rotate the **DIAL** to the original memory channel number!*

Any required CTCSS/DCS changes, or repeater offset modifications, must be done before storing the data into the new (or original) memory channel location.

MASKING MEMORIES

There may be situations where you want to “Mask” memories so they are not visible during memory selection or scanning. For example, several memories used only in a city you visit infrequently may be stored, then “Masked” until you visit that city, at which time you can “Unmask” them for normal use.

- ① Press the **[MR(SK)SC]** key, if needed, to enter the MR mode.
- ② Press and hold in the **[F/W]** key for one second, then rotate the **DIAL** to select the memory channel to be “Masked” from view.
- ③ Press the **[MR(SK)SC]** key. The display will revert to memory channel #1. If you rotate the **DIAL** to the location you just “Masked,” you will observe that it is now invisible.
- ④ To Unmask the hidden memory, repeat the above procedure: press and hold in the **[F/W]** key for one second, rotate the **DIAL** to select the masked memory’s number, then press **[MR(SK)SC]** to restore the memory channel’s data.



Watch out! You can manually store data over a “Masked” memory, deleting previous data, if you’re not careful. Use the “next available memory” technique (look for the [] icon) storage technique to avoid over-writing a masked memory.*

MEMORY GROUP OPERATION

Memory Group Assignment

- ① Recall the memory channel to be assigned to a Memory Group.
- ② Press and hold the **[F/W]** key for one second, then press the numbered key ([1] ~ [5]) you want as the Memory Group for this channel.
- ③ Now memory channel data is copied into the Memory Group.

Memory Group Recall

- ① Press the **[MR(SK)SC]** key to recall the Memory mode.
- ② Press **[F/W]** then **[4(MG)DSP]** to activate the “Memory Group” mode.
- ③ Rotate the **DIAL** knob to select the desired Memory Group (“MG1” ~ “MG5”).
- ④ Press the **[MR(SK)SC]** key momentarily to lock in the selected Memory Group.
- ⑤ In the Memory Group, you select the memory channel in the current memory group only (up to 24 channels).
- ⑥ To exit the Memory Group, press **[VFO(DW)SC]** then **[MR(SK)SC]** to return to the (non-grouped) Memory mode.

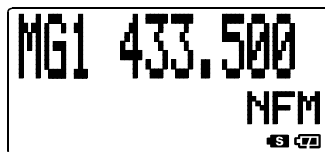

Scanning

The **VX-5R** allows you to scan just the memory channels, the entire operating band, or a portion of that band. It will halt on signals encountered, so you can talk to the station(s) on that frequency, if you like.

Scanning operation is basically the same in each of the above modes. Before you begin, take a moment to select the way in which you would like the scanner to *resume scanning* after it halts on a signal.

Setting the Scan Resume Technique

Three options for the Scan-Resume mode are available:

- 5 SEC: In this mode, the scanner will halt on a signal it encounters, and will hold there for 5 seconds. If you do not take action to disable the scanner within that time period, the scanner will resume even if the stations are still active.
- BUSY: In this mode, the scanner will halt on a signal it encounters. Two seconds after the carrier has dropped because the other station(s) ceased transmission, the scanner will resume. In the case of constant-carrier signals like Weather Station broadcasts, the scanner will likely remain on this frequency indefinitely.
- HOLD: In this mode, the scanner will halt on a signal it encounters. It will not restart automatically; you must manually re-initiate scanning if you wish to resume.

To set the Scan-Resume mode

- ① Press the **[F/W]** key, then press the **[BAND(SET)AR]** key, to enter the Set mode.
- ② Rotate the **DIAL** to select Menu #12 (“RESUME”).
- ③ Press the **[BAND(SET)AR]** key to enable changing of this Menu item.
- ④ Rotate the **DIAL** to select the desired scan-resume mode.
- ⑤ When you have made your selection, press the **PTT** key to save the new setting and exit to normal operation.



The default condition for this Menu Item is “5 SEC.”

VFO SCANNING

This mode allows you to scan the entire current operating band.

- ① Select the VFO mode by pressing the **[VFO(DW)SC]** key, if necessary.
- ② Press and hold in the **[VFO(DW)SC]** key for one second to start scanning.
- ③ If and when the scanner encounters a signal strong enough to open the squelch, the scanner will halt temporarily; the decimal point of the frequency display will blink during this “Pause” condition.
- ④ The scanner will then resume according to the Scan Resume selected in the previous section.
- ⑤ To cancel scanning, press the **PTT**, **[MR(SKP)SC]**, or **[VFO(DW)SC]** key.



*When you press the **[VFO(DW)SC]** key to start scanning, the **VX-5R** will be changing frequency in the upward direction. If you want to change direction of the scan while it is underway, rotate the **DIAL** one click in the opposite direction (in this case, one click counter-clockwise). You'll see the scanner turn around and change frequency downward!*

MEMORY SCANNING

Memory scanning is similarly easy to initiate:

- ① Set the radio to the Memory mode by pressing the **[MR(SKP)SC]** key, if necessary.
- ② Press and hold in the **[MR(SKP)SC]** key for one second to initiate scanning.
- ③ As with VFO scanning, the scanner will halt on any signal encountered that is strong enough to open the squelch; it will then resume scanning according to the Scan-Resume mode set previously.
- ④ To cancel scanning, press the **PTT**, **[MR(SKP)SC]**, or **[VFO(DW)SC]** key.

Scanning

HOW TO SKIP (OMIT) A CHANNEL DURING MEMORY SCAN OPERATION

As mentioned previously, some continuous-carrier stations like a Weather Broadcast station will seriously impede scanner operation if you are using the “Carrier Drop” Scan-Resume mode, as the incoming signal will not pause long enough for the transceiver to resume scanning. Such channels may be “Skipped” during scanning, if you like:

- ① Set the radio to the Memory Mode by pressing the **[MR(SKP)SC]** key, if necessary.
- ② Rotate the **DIAL** to select the Memory Channel to be skipped during scanning.
- ③ Press the **[F/W]** key *momentarily* (not for one second), then press the **[MR(SKP)SC]** key (momentarily). A small “◀” icon will appear to the left of the memorized frequency, indicating it is to be ignored during scanning.

To re-institute the channel into the scanning loop, repeat the above three steps (the “skipped” channel will, of course, still be accessible via manual channel selection methods using the **DIAL** in the MR mode).

PREFERENTIAL MEMORY SCAN

The **VX-5R** also allows you to set up a “Preferential Scan List” of channels which you can “flag” within the memory system. These channels are designated by a “e” icon when you have selected them, one by one, for the Preferential Scan List. When you initiate memory scanning on a channel with the “e” icon appended, only those channels bearing the “e” icon will be scanned. If you initiate scanning on a channel which does not have the “e” icon appended, you will scan all channels including those with the “e” icon appended.

Here is the procedure for setting up and using the Preferential Scan List:

- ① Press the **[MR(SKP)SC]** key momentarily to enter the Memory Recall mode, if you are not using memories already.
- ② Rotate the **DIAL** to select the channel which you wish to add to the Preferential Scan List.
- ③ Press the **[F/W]** key, then press the **[MR(SKP)SC]** key. The “◀” icon will appear beside the channel number. Now press the **[F/W]** key, then press the **[MR(SKP)SC]** key again. The “◀” icon will be replaced by the “e” icon, indicating that the channel is now in the Preferential Scan List.

To initiate Preferential Memory Scan:

- ① Press the **[MR(SKP)SC]** key momentarily to enter the Memory Recall mode, if you are not using memories already.
- ② Rotate the **DIAL** to select any channel which has an “e” icon appended to the channel number.
- ③ Press and hold in the **[MR(SKP)SC]** key for one second to initiate Preferential Memory Scanning. Only the channels which have an “e” icon appended to the channel number will be scanned.

PROGRAMMABLE (BAND LIMIT) MEMORY SCAN (PMS)

This feature allows you to set sub-band limits for either scanning or manual VFO operation. For example, you might wish to set up a limit (in North America) of 144.300 MHz to 148.000 MHz so as to prevent encroachment into the SSB/CW “Weak Signal” portion of the band below 144.300 MHz. Here’s how to do this:

- ① Set the radio to the VFO mode by pressing the **[VFO(DW)SC]** key, if necessary.
- ② Using the techniques learned earlier, store (per the above example) 144.300 MHz into Memory Channel #L1 (the “L” designates the Lower sub-band limit).
- ③ Likewise, store 148.000 MHz into Memory Channel #U1 (the “U” designates the Upper sub-band limit).
- ④ Switch to the Memory mode by pressing the **[MR(SKP)SC]** key once, then rotate the **DIAL** to select Memory Channel # L1.
- ⑤ Press the **[MR(SKP)SC]** key; the “MR” label will be replaced by “PMS” in the upper left-hand corner of the display.
- ⑥ You may now rotate the **DIAL**, or begin scanning by pressing the **[VFO(DW)SC]** key for one second. The transceiver will behave as though it is in the standard VFO mode, but operation will be restricted to the range between Memory Channels L1 and U1.



*If you wish to scan, do not press the **[MR(SKP)SC]** key, as it is disabled during PMS operation. Press and hold in the **[VFO(DW)SC]** key instead.*

- ⑦ Ten pairs of Band Limit memories, labeled L1/U1 through L10/U10 are available. You therefore can set upper and lower operation limits on a number of bands, if you like.

Scanning

“PRIORITY CHANNEL” ESCANNING (DUAL WATCH)

The **VX-5R**'s scanning features include a two-channel scanning capability which allows you to operate on a VFO or Memory channel, while periodically checking a *user-selectable Priority Channel* for activity. If a station is received on the Priority Channel which is strong enough to open the Squelch, the scanner will pause on that station in accordance with the Scan-Resume mode set via Menu #12 (see page 63).

Here is the procedure for activating Priority Channel Dual Watch operation:

- ① Recall the memory channel you wish to be the “Priority” Channel.
- ② Press and hold in the **[F/W]** key for one second, then press the **[BAND(SET)AR]** key. A “P” icon will appear to the right of the memory channel number, indicating it is the priority channel.
- ③ Now set the **VX-5R** for operation on another memory channel, or on a VFO frequency.
- ④ Press the **[F/W]** key, then press the **[VFO(DW)SC]** key (momentarily). The display will remain on the VFO or memory channel selected, but every four seconds the **VX-5R** will check the Priority Channel (now labeled *nP*) for activity (when “*n*” is the channel number).

Changing the Priority Channel

It is possible to set the Priority Channel to any "regular" Memory Channel in the transmitter. To do this:

- ① Press and hold in the **[F/W]** button until the memory channel blinks, then use the **DIAL** knob to select the channel you wish to assign as the Priority Channel.
- ② Now press the **[BAND(SET)AR]** key. The new Priority is now assigned.
- ③ To return the Priority Channel to Channel 1 (default), repeat the above procedure, selecting Channel 1 in step ① above.

Here is the procedure for activating Two-VFO Dual Watch operation:

- ① Press the **[VFO(DW)SC]** key to switch to the VFO mode, if needed.
- ② Press the **[F/W]** key, then press and hold in the **[VFO(DW)SC]** key. The **VX-5R** will now periodically change from the VFO-A frequency to the VFO-B frequency, checking for activity on VFO-B for 0.2 second.

AUTOMATIC LAMP ILLUMINATION ON SCAN STOP

The **VX-5R** will automatically illuminate the LCD Lamp whenever the scanner stops on a signal; this allows you to see the frequency of the incoming signal better at night. Note that this will, of course, increase the battery consumption, so be sure to switch it off during the day (the default condition for this feature is “ON”).

The procedure for disabling the Scan Lamp is:

- ① Press the **[F/W]** key, then press the **[BAND(SET)AR]** key, to enter the Set mode.
- ② Rotate the **DIAL** to select Menu #13 (“SCAN LAMP”).
- ③ Press the **[BAND(SET)AR]** key to enable changing of this Menu item.
- ④ Rotate the **DIAL** to set this Menu item to OFF.
- ⑤ When you have made your selection, press the **PTT** key to save the new setting and exit to normal operation.

BAND EDGE BEEPER

The **VX-5R** will automatically “beep” when a band edge is encountered during scanning (either in standard VFO scanning or during PMS operation). You may disable this feature, if it is annoying, without disabling the keypad beeper (the default condition for this feature is “ON”).

The procedure for disabling the Band-Edge Beeper is:

- ① Press the **[F/W]** key, then press the **[BAND(SET)AR]** key, to enter the Set mode.
- ② Rotate the **DIAL** to select Menu #21 (“EDGE BEEP”).
- ③ Press the **[BAND(SET)AR]** key to enable changing of this Menu item.
- ④ Rotate the **DIAL** to set this Menu item to OFF.
- ⑤ When you have made your selection, press the **PTT** key to save the new setting and exit to normal operation.

Smart Search Operation

The Smart Search feature allows you to load frequencies automatically according to where activity is encountered by your radio. When Smart Search is engaged, the transceiver will search above and below your current frequency, storing active frequencies as it goes (without stopping on them even momentarily); these frequencies are stored into a special Smart Search memory bank, consisting of 31 memories (15 above the current frequency, 15 below the current frequency, plus the current frequency itself).

Two basic operating modes for Smart Search are available:

SINGLE Sweep: In this mode, the transceiver will sweep the current band once in each direction starting on the current frequency. All channels where activity is present will be loaded into the Smart Search memories; whether or not all 31 memories are filled, the search will stop after one sweep in each direction.

CONTINUE: In this mode, the transceiver will make one pass in each direction as with One-Shot searching; if all 31 channels are not filled after the first sweep, however, the radio will continue sweeping until they *are* all filled.

Setting the Smart Search Mode

- ① Press the **[F/W]** key, then press the **[BAND(SET)AR]** key, to enter the Set mode.
- ② Rotate the **DIAL** to select Menu #35 (“SMRT SRCH”).
- ③ Press the **[BAND(SET)AR]** key to enable changing of this Menu item.
- ④ Rotate the **DIAL** to select the desired Smart Search mode (see above).
- ⑤ When you have made your selection, press the **PTT** key to save the new setting and exit to normal operation.

Storing Smart Search Memories

- ① Set the radio to the VFO mode in the desired band.
- ② Press and hold in the **[F/W]** key for one second, then press the **LAMP** key.
- ③ Press the **[VFO(DW)SC]** key to begin the Smart Search scanning.
- ④ As active channels are detected, you will observe the number of “loaded” channels increasing in the regular memory channel window.
- ⑤ Depending on the mode you set for Smart Search operation (SINGLE or CONTINUE), the Smart Search scan will eventually terminate, and the LCD will revert to Smart Search Memory Channel 01.
- ⑥ To *recall* Smart Search memories, rotate the **DIAL** to choose from among the Smart Search memories.
- ⑦ To return to normal operation, Press the **[F/W]** key, then the **LAMP** key.



Smart Search is a great tool when visiting a city for the first time. You don't need to spend hours looking up repeater frequencies from a reference guide-book... just ask your VX-5R where the action is!

Spectrum Analyzer (Spectra-Scope™) Operation

The Spectrum Analyzer (Spectra-Scope™) allows viewing operating activity on channels above or below the current operating channel in the VFO mode.

The display indicates the relative signal strength on channels immediately adjacent to the current operating frequency.

Two basic operating modes for Spectrum Analyzer (Spectra-Scope™) are available:

SINGLE Sweep: In this mode, the transceiver sweeps the current band once.

CONTINUE: In this mode, the transceiver sweeps the current band repeatedly until the Spectrum Analyzer (Spectra-Scope™) is turned off.

Setting the Spectrum Analyzer (Spectra-Scope™) mode

- ① Press the **[FW]** key, then press the **[BAND(SET)AR]** key, to enter the SET mode.
- ② Rotate the **DIAL** to select Menu #34 (“SPEC-ANAL”).
- ③ Press the **[BAND(SET)AR]** key to enable changing of this Menu item.
- ④ Rotate the **DIAL** to select the desired Spectrum Analyzer (Spectra-Scope™) mode (see above).
- ⑤ When you have made your selection, press the **PTT** key to save the new setting and exit to normal operation.

To Activate the Spectrum Analyzer (Spectra-Scope™):

- ① Set the radio to the VFO mode in the desired band.
- ② Press the **[FW]** key momentarily, then press the **LAMP** key.

When the Spectrum Analyzer (Spectra-Scope™) is activated, *eleven* channels are viewed per sweep. The visible bandwidth, however, depends on the selected channel step size, so match the default channel steps with the amateur band you are using.

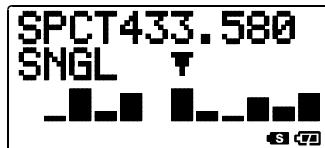

To turn the Spectrum Analyzer (Spectra-Scope™) off and operate on the centered (and displayed) channel, press the **PTT** switch momentarily, then press **[FW]** key, followed by **LAMP** key.

Barometric Pressure/Altitude Metering

The optional Barometric Pressure unit (**SU-1**) brings to the **VX-5R** the unique capability of providing readout of the current barometric pressure. This information is then used for calculation of your current altitude, when hiking, etc.

The Barometric Pressure unit requires calibration of the “offset” parameters, so that differences in pressure can be used to calculate altitude. This procedure requires that you have a calibrated barometer, and that you know your current altitude. If you are at sea level, of course, the latter parameter requires no research.

Correcting the Atmospheric Pressure Meter (Barometer Offset)

- ① Press the **[F/W]** key, then press the **[BAND(SET)AR]** key to enter the Set Mode.
- ② Rotate the **DIAL** to select Menu Item #43 (“BARO OFST”), then press the **[BAND(SET)AR]** key momentarily.
- ③ Turn the **DIAL** to set the difference (value) between the **VX-5R** display and the calibrated barometer display. *For example*, if the **VX-5R** display shows “1024 hpa” and calibrated barometer indicates “1029 hpa”, set the Barometer offset to “+5”.
- ④ Press the **PTT** key momentarily to save the your new setting and exit to normal operation.



Use the chart on the next page to convert from “hpa” to “Inches of Mercury” if your barometer does not read metric values.

Correcting the Altimeter Setting (Altimeter Offset)

- ① Press the **[F/W]** key, then press the **[BAND(SET)AR]** key to enter the SET Mode.
- ② Rotate the **DIAL** to select Menu Item #44 (“ALTI OFST”), then press the **[BAND(SET)AR]** key momentarily.
- ③ Turn the **DIAL** to set the difference (value) between the **VX-5R**’s currently-displayed value and current location’s altitude. *For example*, if the **VX-5R** display indicates “2m” while you actually are at sea level, set the Altimeter offset to “-2” in this step. You can set the ALTI OFST at any place (other than sea level) if you know the true altitude at you current location.
- ④ Press the **PTT** key momentarily to save the your new setting and exit to normal operation.

Barometric Pressure/Altitude Metering

Once you have completed the above calibration, you can confirm the current Barometric Pressure, or your current Altitude, from the front panel's keypad:

How to Measure the Barometric Pressure

Press and hold in the [8(BRO)] key to display the current Barometric Pressure. The pressure in millibars will be displayed below the frequency. If you leave the display in this mode, a bar graph will be created, over time, to indicate relative changes in the pressure (two bars per hours).

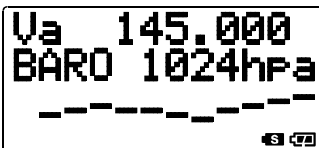

To return to normal operation, press and hold the [8(BRO)] key for one second. If you were operating with the Main VFO field enlarged, press [4(MG)DSP] key instead.

How to Measure the Altitude

Press and hold in the [9(BP)ALT] key to display the current Altitude.

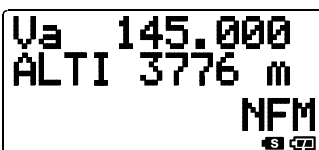

To return to normal operation, press and hold the [9(BP)ALT] key for one second. If you were operating with the Main VFO field enlarged, press [4(MG)DSP] key instead.

Barometric Pressure Conversion Chart (Rounded to nearest whole number)

hpa (mb)	Inches	hpa (mb)	Inches	hpa (mb)	Inches	hpa (mb)	Inches
982	29.0	1001	29.55	1011	29.85	1026	30.3
985	29.1	1002	29.6	1013	29.9	1029	30.4
989	29.2	1004	29.65	1014	29.95	1033	30.5
992	29.3	1006	29.7	1016	30.0	1036	30.6
996	29.4	1007	29.75	1019	30.1		
999	29.5	1009	29.8	1023	30.2		

Display Customization

The **VX-5R**'s display includes several unique customization options which can expand your enjoyment of your transceiver.

ICON MODE

The display's alphanumeric labels can be replaced by pictorial icons, which may be easier to remember during operation.

To activate the **ICON** mode, press and hold in the **[5(AP)ICO]** key for one second. The display will change to incorporate the default icons, as stored in the microprocessor's firmware.

You can also modify the Icon which represents a particular operating function.

ICON Selection

- ① Press the **[F/W]** key, then press the **[BAND(SET)AR]** key to enter the SET Mode.
- ② Rotate the **DIAL** to select Menu Item #4 ("ICON"), then press the **[BAND(SET)AR]** key momentarily.
- ③ Turn the **DIAL** to select the desired band or mode on which you wish to utilize an Icon, then press the **[BAND(SET)AR]** key momentarily.
- ④ Turn the **DIAL** to select the desired Icon to be displayed in place of the regular indicator.
- ⑤ Press the **PTT** key momentarily to save the your new setting and exit to normal operation.

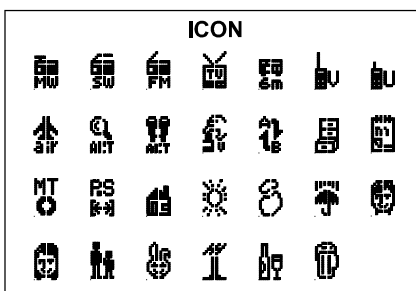

METER SYMBOLS

The S- and TX Power Meter is a "bar graph" type of display. The default ">>" symbol which is used for this meter may be replaced by several other symbols, if desired.

- ① Press the **[F/W]** key, then press the **[BAND(SET)AR]** key to activate the Set mode.
- ② Rotate the **DIAL** to select Menu #42 ("MTR SYMB").
- ③ Press the **[BAND(SET)AR]** key momentarily to enable modification of this Menu item.
- ④ Rotate the **DIAL** to select from among the available symbols: >>, ■, ●, =, ►, -, CHR.
- ⑤ If you select the "CHR" (Character), press the **[BAND(SET)AR]** key to begin entry of the character (letters and numbers) in the "bar graph".
- ⑥ Rotate the **DIAL** to select the character in the first digit, then press the **[BAND(SET)AR]** key to move to the next digit.
- ⑦ Repeat previous step as necessary to complete, pressing the **[BAND(SET)AR]** key after each entry.
- ⑧ When you have made your choice, press the **PTT** key to save your selection and exit to normal operation.

Display Customization

POWER-OFF DISPLAY MODE

When the **VX-5R** is turned off, the LCD may be set up to display one or more environmental measurements. These include temperature, barometric pressure, altitude, or combinations of these.

- ① Press the **[F/W]** key, then press the **[BAND(SET)AR]** key to activate the Set mode.
- ② Rotate the **DIAL** to select Menu #45 (“DISP MODE”).
- ③ Press the **[BAND(SET)AR]** key momentarily to enable modification of this Menu item.
- ④ Rotate the **DIAL** to select the new setting. The options include
 - NONE: No display when the transceiver is off.
 - TEMP: Display of temperature when the transceiver is off.
 - BARO: Display of barometric pressure when the transceiver is off. (requires optional **SU-1**). A bar graph will indicate relative changes in the pressure (two bars per hour).
 - ALTI: Display of the current altitude when the transceiver is off. (requires optional **SU-1**)
 - TEMP + BARO: Display of temperature plus barometric pressure.
 - TEMP + ALTI: Display of temperature plus altitude.
 - ALL: Display of temperature plus barometric pressure plus altitude.
- ⑤ When you have made your selection, press the **PTT** key to save the new setting and exit to normal operation.



*If any of the above settings is enabled (i.e. any setting except “NONE”), current drain with the **VX-5R** turned off will be about 20 mA. We recommend that the Power-Off Display Mode be set to “NONE” if you plan to be away from the radio for an extended period of time.*

DISPLAY CONTRAST

The LCD’s contrast may be adjusted using the Menu, as well.

- ① Press the **[F/W]** key, then press the **[BAND(SET)AR]** key to activate the Set mode.
- ② Rotate the **DIAL** to select Menu #41 (“CONTRAST”).
- ③ Press the **[BAND(SET)AR]** key momentarily to enable modification of this Menu item.
- ④ Rotate the **DIAL** to adjust the contrast. As you make the adjustment, you will be able to see the effects of your changes.
- ⑤ When you have completed the adjustment, press the **PTT** key to save the new setting and exit to normal operation.

Reset

MICROPROCESSOR RESETTING

- ① Turn the radio off.
 - ② Press and hold the [**4(MG)DSP**], [**MR(SKP)SC**], and [**VFO(DW)SC**] key while turning the radio on.
 - ③ Press the [**F/W**] key momentarily to initialize the radio.
-

SET MODE RESETTING

- ① Turn the radio off.
- ② Press and hold the [**MR(SKP)SC**] and [**VFO(DW)SC**] key while turning the radio on.
- ③ Press the [**F/W**] key momentarily to initialize the Set mode.

The **VX-5R** includes a convenient “Clone” feature, which allows the memory and configuration data from one transceiver to be transferred to another **VX-5R**. This can be particularly useful when configuring a number of transceivers for a public service operation. Here is the procedure for Cloning one radio’s data to another:

- ① Turn both radios off.
- ② Connect the optional **CT-27** cloning cable between the **MIC/EAR** jacks of the two radios.
- ③ Press and hold the **[F/W]** key while turning the radios on. Do this for both radios (the order of the switch-on does not matter). “CLONE” will appear on the displays of both radios when the Clone mode is successfully activated in this step.
- ④ On the *Destination* radio, press the **[MR(SKP)SC]** key (“CLONE WAIT” will appear on the LCD).
- ⑤ Press the **[VFO(DW)SC]** key on the *Source* radio; “CLONE TX” will appear on the Source radio, and the data is transferred.
- ⑥ If there is a problem during the cloning process, “CLONE ERROR” will be displayed. Check your cable connections and battery voltage, and try again.
- ⑦ If the data transfer is successful, the *Destination* radio will return to normal operation; the *Source* radio will still be in the clone mode, with “CLONE TX” still displayed. Turn both radios off and disconnect the **CT-27**. You can then turn the radios back on, and begin normal operation.



CLONE WAIT



CLONE TX

Set Mode

The **VX-5R** Set (Menu) mode is easy to activate and set. Use the following procedure:

- ① Press the **[F/W]** key, then press the **[BAND(SET)AR]** key, to activate the Set mode.
- ② Turn the **DIAL** to select the Menu item number to be adjusted.
- ③ Press the **[BAND(SET)AR]** key momentarily, then rotate the **DIAL** to adjust or select the parameter to be changed on the Menu item selected in above step.
- ④ After completing your selection and adjustment, press the **PTT** switch momentarily to exit the Set mode and exit to normal operation.

Set Mode Summary

Item #	Menu Item	Function	Available Values	Default
1	SQUELCH	Set the AM and FM-N Squelch threshold level	0 ~ 15	01
2	WFM SQL	Set the FM-Wide Squelch threshold level	0 ~ 8	02
3	NAME SET	Store Alpha-Numeric "Tags"	-	-
4	ICON	ICON Select	-	-
5	VFO	Select/disable the VFO Band edge	ALL/BAND	BAND
6	ARS	Enable/disable the Automatic Repeater Shift	ON/OFF	ON
7	RPT SHIFT	Set the Repeater Shift Direction	-RPT/+RPT/SIMP	*
8	SHIFT	Set the magnitude of the Repeater Shift	0.00 ~ 99.95 MHz	
9	VFO SPLIT	Enable/disable "VFO Split" Operation	ON/OFF	OFF
10	VFO LINK	Enable/disable VFO Link feature	ON/OFF	OFF
11	VFO STEP	Setting of the synthesizer steps	5/9/10/12.5/15/20/ 25/50/100 kHz	*
12	RESUME	Select the Scan Resume mode	5 SEC/BUSY/HOLD	5 SEC
13	SCAN LAMP	Enable/disable the Scan lamp	ON/OFF	ON
14	RX SAVE	Select the Rx-mode Battery Saver interval	OFF/200mS/300mS/ 500mS/1S/2S	200mS
15	TX SAVE	Enable/disable the Transmit Battery Saver	ON/OFF	OFF
16	APO	Set the Automatic Power-Off time	OFF/30min/1hour/3hour/ 5hour/8hour	OFF
17	BUSY LED	Enable/disable the BUSY LED	ON/OFF	ON
18	ARTS BEEP	Select the Beep option during ARTS operation	IN RANGE/ALWAYS/OFF	IN RANGE
19	ARTS ITVL	Select the Polling Interval during ARTS operation	15 SEC/25 SEC	25 SEC
20	KEY BEEP	Enable/disable the Keypad beeper	ON/OFF	ON
21	EDGE BEEP	Enable/disable the Band-edge beeper	ON/OFF	OFF
22	BELL	Select the CTCSS Bell ringer repetitions	OFF/1/3/5/8/REPEAT	OFF
23	MON/T-CAL	Select the MON key function	MON/T-CAL	*
24	HOME/REV	Select the function of [HM/RV(EMG)] key	HOME/REV	
25	LAMP MODE	Select the LCD/Keypad Lamp mode	KEY/TOGGLE/5 SEC	KEY
26	TOT	Set the TOT time	OFF/1min/2.5min/ 5min/10min	2.5min
27	BCLO	Enable/disable the Busy Channel Lock-Out	ON/OFF	OFF
28	CLOCK SFT	Shifting of CPU clock frequency	ON/OFF	OFF
29	SQL TYPE	Select the Tone Encoder and/or Decoder mode	OFF/TONE/TONE SQL/DCS	OFF

Item #	Menu Item	Function	Available Values	Default
30	TONE SET	Setting of the CTCSS Tone Frequency	39 standard CTCSS tones	100 Hz
31	DCS SET	Setting of the DCS code	104 standard DCS codes	023
32	DTMF SET	Programming the DTMF Autodialer	-	-
33	CW ID	Programming and activate the CW IDer	-	-
34	SPEC-ANA-L	Select the Spectrum Analyzer Sweep mode	SINGLE/CONTINUE	SINGLE
35	SMRT SRCH	Select the Smart Search Sweep mode	SINGLE/CONTINUE	SINGLE
36	RX MODE	Select the Operating mode	AUTO/N-FM/W-FM/AM	AUTO
37	LOCK MODE	Select the Control Locking lockout combination	KEY/DIAL/PTT/KEY+DIAL/KEY+PTT/DIAL+PTT/ALL	KEY
38	HALF DEV	Reducing the Deviation level by 50%	ON/OFF	OFF
39	LANGUAGE	Select the language for the Set (menu) mode	ENGLISH/JAPANESE	ENGLISH
40	ON TIMER	Set the ON Timer time	OFF ~ 24:00	OFF
41	CONTRAST	Setting of the Display contrast level	1 ~ 10	5
42	MTR SYMB	Select the S/P/O meter Symbol	», ■, ●, =, ◆, -, CHR	»
43	BARO OFST	Correcting the atmospheric pressure	-500 ~ +500 hpa (mb)	0 hpa (mb)
44	ALTI OFST	Correcting the altimeter setting	-500 ~ +500 m	0 m
45	DISP MODE	Select the display while the Transceiver's power is off	NONE/TEMP/BARO/ALTI/TEMP+BARO/TEMP+ALTI/ALL	NONE

※: Depends on the transceiver version.

Set Mode Details

Set Item 1 [SQUELCH]

Function: Set the Squelch threshold level for the AM and FM-Narrow modes.

Available Values: 0 ~ 15

Default: 01

Set Item 2 [WFM SQL]

Function: Set the Squelch threshold level for the FM-Wide mode.

Available Values: 0 ~ 15

Default: 02

Set Item 3 [NAME SET]

Function: Store Alpha-Numeric “Tags” for the Memory channels.

Name Storing:

- ① Recall the memory channel to be named.
- ② Recall Menu Item 3, then press the [BAND(SET)AR] key momentarily.
- ③ Turn the **DIAL** to select the desired first letter, number, or symbol, then press the [BAND(SET)AR] key momentarily to save the first letter/number/ symbol.
- ④ Repeat the previous step as necessary to complete, pressing the [BAND(SET)AR] key after each entry.
- ⑤ Press the **PTT** key momentarily to save the your new setting and exit to normal operation.

Set Mode

Set Item 4 [ICON]

Function: ICON selection.

- ① Recall Menu Item 3, then press the **[BAND(SET)AR]** key momentarily.
- ② Turn the **DIAL** to select the desired band or mode on which you wish to utilize an Icon, then press the **[BAND(SET)AR]** key momentarily.
- ③ Turn the **DIAL** to select the desired Icon to be displayed in place of the regular indicator.
- ④ Press the **PTT** key momentarily to save the your new setting and exit to normal operation.

Set Item 5 [VFO]

Function: Select or disable the VFO Band edge for the current band.

Available Values: ALL/BAND

Default: BAND

ALL: When the VFO frequency reaches the high edge of the current band, the VFO frequency will jump to the *low band edge of the next band* (or vice versa).

BAND: When the VFO frequency reaches the high band edge of the current band, the VFO frequency will jump to the low band edge of the *current band* (or vice versa).

Set Item 6 [ARS]

Function: Enable/disable the Automatic Repeater Shift function.

Available Values: ON/OFF

Default: ON

Set Item 7 [RPT SHIFT]

Function: Set the Repeater Shift Direction

Available Values: -RPT/+RPT/SIMP

Default: Depends on the transceiver version.

Set Item 8 [SHIFT]

Function: Set the magnitude of the Repeater Shift.

Available Values: 0.00 ~ 99.95 MHz

Default: Depends on the transceiver version, as well as the setting of Menu #06 (ARS).

Set Item 9 [VFO SPLIT]

Function: Enable/disable “VFO Split” Operation

Available Values: ON/OFF

Default: OFF

When this feature “ON,” you can operate in a “split” mode between the Main and Sub VFO frequencies (the Main VFO will be used for Rx, while the Sub VFO will be used for Tx).

Set Item 10 [VFO LINK]

Function: Enable/disable the VFO Link feature.

Available Values: ON/OFF

Default: OFF

When this feature “ON,” the Main and Sub VFOs are “slaved” so that they change frequency together.

Set Item 11 [VFO STEP]

Function: Setting of the synthesizer steps.

Available Values: 5/10/12.5/15/20/25/50/100 kHz

Default: Depends on the transceiver version.

Set Item 12 [RESUME]

Function: Select the Scan Resume mode.

Available Values: 5 SEC/BUSY/HOLD

Default: 5 SEC

5 SEC: The scanner will hold for 5 seconds, then resume whether or not the other station is still transmitting.

BUSY: The scanner will hold until the signal disappears, then will resume when the carrier drops.

HOLD: The scanner will stop when a signal is received, and will not restart.

Set Item 13 [SCAN LAMP]

Function: Enable/disable the Scan lamp while paused.

Available Values: ON/OFF

Default: ON

Set Item 14 [RX SAVE]

Function: Select the Receive-mode Battery Saver interval (“sleep” ratio).

Available Values: OFF/200mS(1:1)/300mS(1:1.5)/500mS(1:2.5)/1s(1:5)/2s(1:10)

Default: 200mS(1:1)

Set Item 15 [TX SAVE]

Function: Enable/disable The Transmit Battery Saver.

Available Values: ON/OFF

Default: OFF

Set Item 16 [APO]

Function: Set the Automatic Power-Off time.

Available Values: OFF/30 min/1 hour/3 hours/5 hours/8 hours

Default: OFF

Set Mode

Set Item 17 [BUSY LED]

Function: Enable/disable the BUSY LED while the Squelch is open.

Available Values: ON/OFF

Default: ON

Set Item 18 [ARTS BEEP]

Function: Select the Beep option during ARTS operation.

Available Values: IN RANGE/ALWAYS/OFF

Default: IN RANGE

IN RANGE: Beeps sound only when the radio first detects that you are within range.

ALWAYS: Beeps sound every time a polling transmission is received from the other station (every 15 or 25 seconds when in range).

OFF: No alert beeps sound.

Set Item 19 [ARTS ITVL]

Function: Select the Polling Interval during ARTS operation.

Available Values: 15 SEC/25 SEC

Default: 25 SEC

This setting determines how often the other station will be polled during ARTS operation.

Set Item 20 [KEY BEEP]

Function: Enable/disable the Keypad beeper.

Available Values: ON/OFF

Default: ON

Set Item 21 [EDGE BEEP]

Function: Enable/disable the Band-edge beeper while scanning.

Available Values: ON/OFF

Default: OFF

When this feature “ON,” a beep will sound when the scanner reaches the band edge (during VFO Scanning) or when it reaches Memory channel “1” (during Memory Channel Scanning).

Set Item 22 [BELL]

Function: Select the CTCSS Bell ringer repetitions.

Available Values: OFF/1/3/5/8/REPEAT

Default: OFF

Set Item 23 [MON/T-CAL]

Function: Select the **MONI** key (just below the **PTT** switch) function.

Available Values: MON/T-CAL

Default: Depends on the transceiver version.

MON: Pressing the **MONI** key causes the noise/tone Squelch to be over-ridden, allowing you to listen for weak (or non-encoded) signals.

T-CAL: Pressing the **MONI** key activates a 1750-Hz burst tone, used for repeater access in many countries.

Set Item 24 [HOME/REV]

Function: Select the function of the [**HM/RV(EMG)**] key.

Available Values: HOME/REV

Default: Depends on the transceiver version.

HOME: Pressing this key instantly recalls a favorite “Home” channel.

REV: Pressing this key reverses the transmit and receive frequencies during repeater operation.

Set Item 25 [LAMP MODE]

Function: Select the LCD/Keypad Lamp mode.

Available Values: KEY/TOGGLE/5 SEC

Default: KEY

KEY: Illuminates the LCD/Keypad for 5 seconds when any key is pressed.

TOGGLE: Pressing the **LAMP** key toggles LCD/Keypad lamp On/Off.

5 SEC: Pressing the **LAMP** key illuminates the LCD/Keypad for 5 seconds.

Set Item 26 [TOT]

Function: Set the TOT time.

Available Values: OFF/1 min/2.5 min/5 min/10 min

Default: 2.5 min

The time-out timer shuts off the transmitter after continuous transmission of the programmed time.

Set Item 27 [BCLO]

Function: Enable/disable the Busy Channel Lock-Out feature.

Available Values: ON/OFF

Default: OFF

Set Item 28 [CLOCK SFT]

Function: Shifting of CPU clock frequency.

Available Values: ON/OFF

Default: OFF

This function is only used to move a spurious response “birdie” should it fall on a desired frequency.

Set Mode

Set Item 29 [SQL TYPE]

Function: Select the Tone Encoder and/or Decoder mode.

Available Values: OFF/TONE/TONE SQL/DCS

Default: OFF

TONE: CTCSS Encoder

TONE SQL: CTCSS Encoder/Decoder

DCS: Digital Coded Squelch Encoder/Decoder

Set Item 30 [TONE SET]

Function: Setting of the CTCSS Tone Frequency

Available Values: 39 standard CTCSS tones

Default: 100 Hz



In this mode, press the [2(CD)TAG] key (not PTT) to save the new setting and exit to normal operation.

Set Item 31 [DCS SET]

Function: Setting of the DCS code.

Available Values: 104 standard DCS codes.

Default: 023



In this mode, press the [2(CD)TAG] key (not PTT) to save the new setting and exit to normal operation.

Set Item 32 [DTMF SET]

Function: Programming the DTMF Autodialer.

DTMF Autodialer Programming:

- ① After selecting Menu Item 32, press the [BAND(SET)AR] key momentarily.
- ② Rotate the **DIAL** to select the autodial memory number you want to store (9 memories are available).
- ③ Press the [BAND(SET)AR] key momentarily, then key in the phone number you want to store (maximum: 16 digits).
- ④ If you make a mistake, press the **MONI** key *twice* to clear the current digit and re-enter the correct number.
- ⑤ After entering the final digit, press the **PTT** key momentarily to save the new setting and exit to normal operation.

Set Item 33 [CW ID]

Function: Program and activate the CW Identifier (used during ARTS operation).

CW IDer Programming:

- ① After selecting Menu Item 33, press the **[BAND(SET)AR]** key momentarily.
- ② Turn the **DIAL** one click to change the display from OFF to ON (CW IDer ON).
- ③ Press the **[BAND(SET)AR]** key momentarily, then turn the **DIAL** to select the first letter/number of your callsign, and press the **[BAND(SET)AR]** key momentarily to save the first letter/number.
- ④ Repeat the previous step as necessary to complete your callsign, pressing the **[BAND(SET)AR]** key after each entry.
- ⑤ Press the **PTT** key momentarily to save the new setting and exit to normal operation.

Set Item 34 [SPEC-ANAL]

Function: Select the Spectrum Analyzer (Spectra-Scope™) Sweep mode.

Available Values: SINGLE/CONTINUE

Default: SINGLE

SINGLE: The transceiver sweeps the current band once.

CONTINUE: The transceiver sweeps the current band repeatedly until the Spectrum Analyzer (Spectra-Scope™) is turned off

Set Item 35 [SMRT SRCH]

Function: Select the Smart Search Sweep mode.

Available Values: SINGLE/CONTINUE

Default: SINGLE

SINGLE: The transceiver sweeps the current band once in each direction starting on the current frequency. All channels where activity is present (up to 15 in each direction) are loaded into the Smart Search memories. Whether or not all 31 memories are filled, the search stops after one sweep in each direction.

CONTINUE: The transceiver makes a sweep in each direction as with the “SINGLE” mode, but if all 31 channels are not filled after the first sweep, the radio continues sweeping until they are *all* filled.

Set Item 36 [RX MODE]

Function: Select the Operating mode.

Available Values: AUTO/N-FM/AM/W-FM

Default: AUTO (Mode automatically changes according to operating frequency)

Set Item 37 [LOCK MODE]

Function: Select the Control Locking lockout combination.

Available Values: KEY/DIAL/PTT/KEY+DIAL/KEY+PTT/DIAL+PTT/ALL

Default: KEY

Set Mode

Set Item 38 [HALF DEV]

Function: Reducing the Deviation level by 50%.

Available Values: ON/OFF

Default: OFF

Set Item 39 [LANGUAGE]

Function: Select the language for the SET (Menu) mode selections.

Available Values: ENGLISH/JAPANESE

Default: ENGLISH

Set Item 40 [ON TIMER]

Function: Set the ON Timer time.

Available Values: OFF ~ 24:00

Default: OFF

The ON Timer turns on the radio at the programmed time.

Set Item 41 [CONTRAST]

Function: Setting of the Display contrast level.

Available Values: 1 ~ 10

Default: 5

Set Item 42 [MTR SYMB]

Function: Select the S/PO meter Symbol.

Available Values: >>, ■, ●, =, ►, -, CHR

Default: >>

Set Item 43 [BARO OFST]

Function: Correcting the atmospheric pressure.

Available Values: -500 ~ +500 hpa (mb)

Default: 0 hpa (mb)

Set Item 44 [ALTI OFST]

Function: Correcting the altimeter setting.

Available Values: -500 ~ +500 m

Default: 0 m

Set Item 45 [DISP MODE]

Function: Select the display while the transceiver's power is off

Available Values: NONE/TEMP/BARO/ALTI/TEMP+BARO/TEMP+ALTI/ALL

Default: NONE

NONE: No display when the transceiver is off.

TEMP: The current temperature will be displayed while the transceiver's power is off.

BARO: The current barometric pressure will be displayed while the transceiver's power is off.

ALTI: The current altitude will be displayed while the transceiver's power is off (calculated from the barometric pressure).

TEMP+BARO: The current temperature and barometric pressure will be displayed while the transceiver's power is off.

TEMP+ALTI: The current temperature and altitude will be displayed while the transceiver's power is off.

ALL: The current temperature, barometric pressure and altitude will be displayed while the transceiver's power is off.

Specifications

General

Frequency Ranges:	Rx: 0.5-1.8 MHz (BC Band) 1.8-16 MHz (SW Band) 48-59 MHz (50 MHz HAM) 59-108 MHz (FM) 108-137 MHz (Air Band) 137-174 MHz (144 MHz HAM) 174-222 MHz (VHF-TV) 222-420 MHz (ACT1: Action Band 1) 420-470 MHz (430 MHz HAM) 470-729 MHz (UHF-TV) 800-999 MHz (ACT2: Action Band 2, Cellular Blocked)
	Tx: 50-54 MHz or 50-52 MHz 144-146 MHz or 144-148 MHz 430-440 MHz or 430-450 MHz
Channel Steps:	5/9/10/12.5/15/20/25/50/100 kHz
Frequency Stability:	±5 ppm (−10°C to +60°C)
Repeater Shift (default):	±600 kHz (144 MHz) ±1.6/5.0/7.6 MHz (430 MHz)
Emission Type:	F2, F3
Antenna Impedance:	50 Ω
Supply Voltage:	Nominal: 7.2 V DC, Negative Ground Operating: 10-16 V DC, Negative Ground (EXT DC jack)
Current Consumption:	150 mA (Receive) 55 mA (Standby, Saver Off) 25 mA (Standby, Saver On) 700 μA (Auto Power Off) 1.6 A (5 W Tx, 50 MHz) 1.7 A (5 W Tx, 144 MHz) 1.9 A (4.5 W Tx, 430 MHz)
Operating Temperature:	−20°C to +60°C
Case Size:	58 (W) x 88 (H) x 27 (D) mm (w/o knob & antenna)
Weight:	255 g

Transmitter

RF Power Output:	5 W (@ 13.8 V EXT DC IN) 5W (@ 7.2 V, 50 MHz/144 MHz) 4.5W (@ 7.2 V 430 MHz)
Modulation Type:	Variable Reactance
Maximum Deviation:	±5 kHz
Spurious Emission:	At least 60 dB below
Microphone Impedance:	2 k Ω

Receiver

Circuit Type:	Double-Conversion Superheterodyne
Intermediate Frequencies:	1st: 47.25 MHz (N-FM) 45.8 MHz (W-FM) 2nd: 450 kHz (N-FM) 10.7 MHz (W-FM)
Sensitivity:	0.5 μ V for 10 dB S/N (0.5-16 MHz, AM) 0.9 μ V for 12 dB SINAD (76-108MHz/174-222MHz, W-FM) 3 μ V for 12 dB SINAD (470-540MHz/630-729MHz, W-FM) 0.16 μ V for 12 dB SINAD (50-54 MHz/144-148 MHz) 0.18 μ V for 12 dB SINAD (430-450 MHz, N-FM)
Selectivity:	15 kHz/35 kHz (-6dB/-60dB: N-FM)
AF Output:	400 mW @ 8 Ω for 10 % THD (@ 7.2 V DC)

Specifications are subject to change without notice, and are guaranteed within amateur bands only.

Frequency ranges, channel steps, and repeater shift vary according to transceiver version; check with your dealer.

Installation of the SU-1

- ① Make sure that the transceiver is off. Remove the hard or soft case, if used.
- ② Remove the battery pack.
- ③ Locate the connector for the **SU-1** under the caution seal in the battery compartment on the back of the radio, just peel off the caution seal.
- ④ Align the connector on the **SU-1** with the transceiver's connector and gently press the unit into place.
- ⑤ Affix the new (supplied) caution seal, and replace the battery.
- ⑥ Installation is now complete.

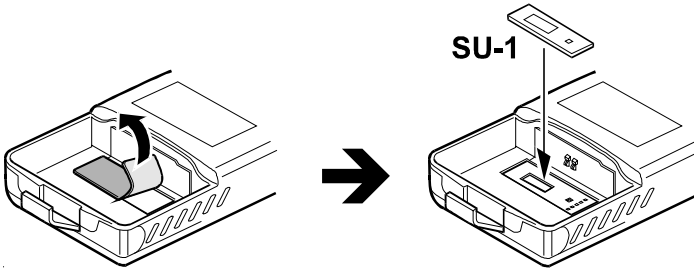

Important Note

The Barometric Pressure/Altitude features of the optional **SU-1** are designed to be supplemental aids for the information of the user, and are not intended to be a substitute for accurate, calibrated Barometer or Altimeter devices used for navigation critical to personal safety.

This device complies with Part 15 of the FCC rules.
Operation is subject to the condition that this device
does not cause harmful interference.



Copyright 2004
VERTEX STANDARD CO., LTD.
All rights reserved.

No portion of this manual
may be reproduced
without the permission of
VERTEX STANDARD CO., LTD.

Printed in Japan

0308q-fY



E 1 2 6 9 1 0 0 8